

Electrically Short Antennas

(PASSIVE & ACTIVE ANTENNAS)

FOR GENERAL APPLICATIONS

Ulrich L. Rohde

Magdalena Salazar-Palma

Tapan K. Sarkar

ANTENNA FARM



Ulrich L. Rohde radio house

INTRODUCTION

- Antennas are used for converting conducted electromagnetic waves into electromagnetic waves freely propagating in space and vice versa.

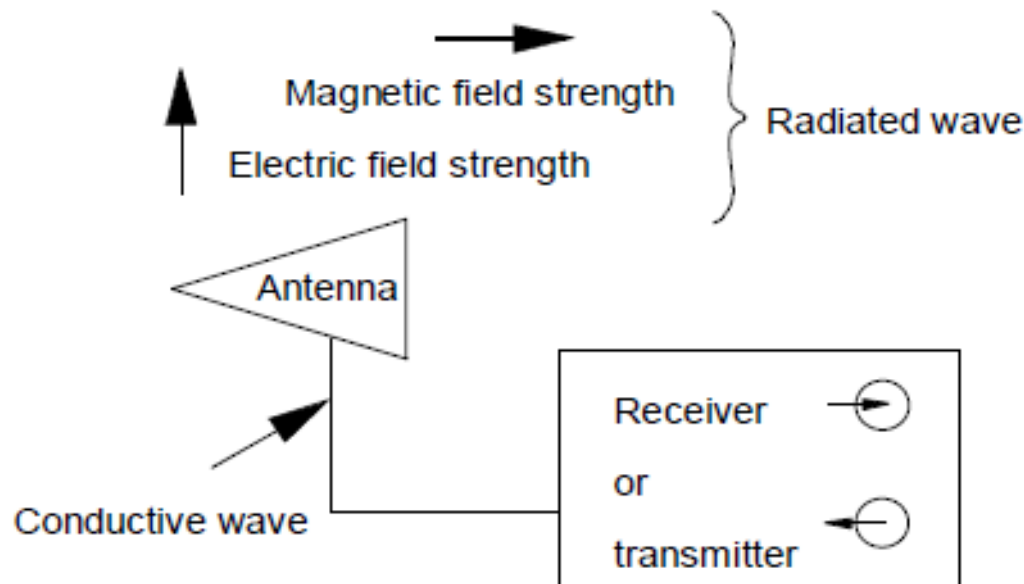

Conventional Passive Antenna - Can be used to transmit as well as receive

INTRODUCTION ... CONT.

- ⦿ Electrically short antennas (also mechanically) are used on airplanes (like slot antennas), on vehicles and shipboard applications
- ⦿ The need for small antennas comes from lack of space for these applications.
- ⦿ We distinguish passive antennas and active antennas

ORIGIN OF 'ANTENNA'



- The origin of the word antenna is attributed to Guglielmo Marconi.
- In 1895, while testing early radio apparatus in the Swiss Alps at Salvan, Switzerland in the Mont Blanc region, Marconi experimented with long wire "aerials". He used a 2.5 meter vertical pole, with a wire attached to the top running down to the transmitter, as a radiating and receiving aerial element. Today this is called as the random length wire antenna. It is NOT resonant. In Italian a tent pole is known as l'antenna centrale, and the pole with the wire was simply called l'antenna.

OTHER ORIGIN OF 'ANTENNA'

- From the field of zoology, the term antennae (Latin) is used to designate the long thin feelers of insects (used as sensors).
- The oldest existing antennas, e.g. those used by *Heinrich Hertz in 1888 in his first experiments* for proving the existence of electromagnetic waves, were neither physically nor functionally separated from high-frequency generators, and up to the present day resonant circuits are taken as models for illustrating certain antenna characteristics.
- It was not until around and after 1900 that antennas were clearly separated and regarded an independent unit in a radio system as transmitting and receiving stations were set up.

ANTENNA USED BY G. MARCONI



SPARK GAP TRANSMITTER- (RECEIVER)

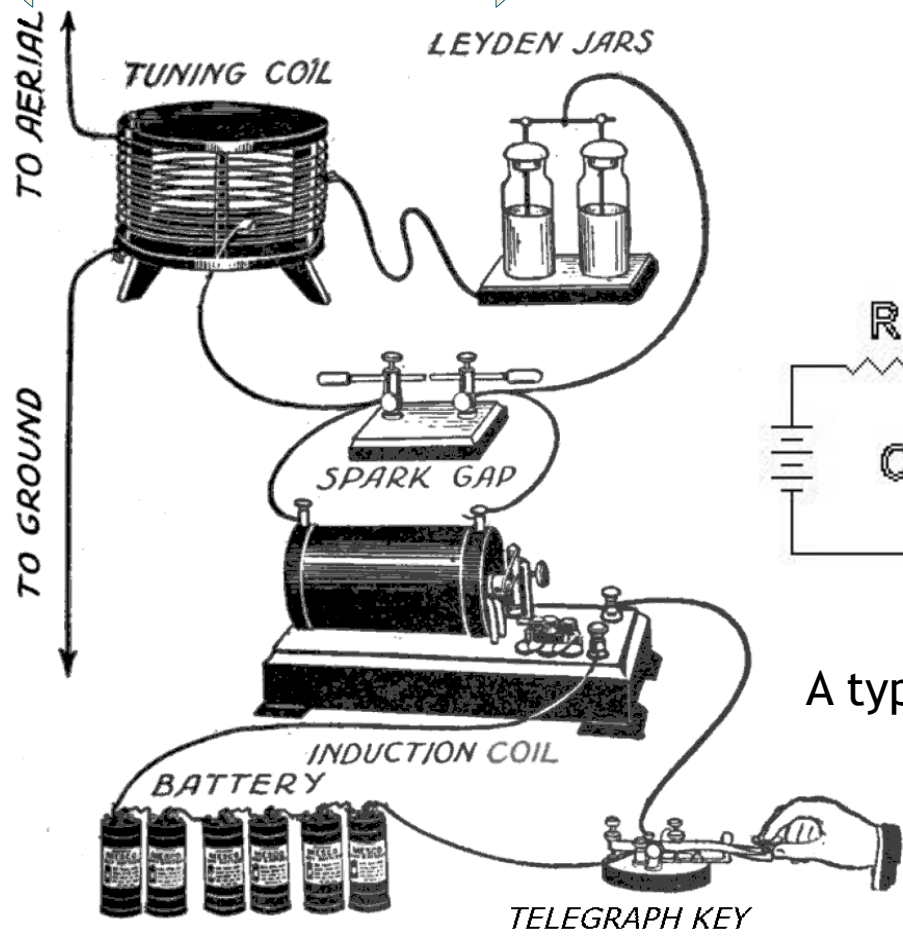

A typical Spark-gap transmitter

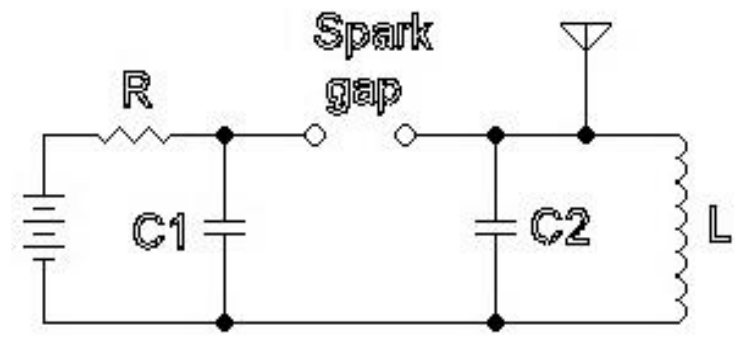

A typical Spark-gap receiver

DIPOLE ANTENNA-HERTZ



- Heinrich Rudolf Hertz built first Antenna (dipole antenna) in 1888
- This was a half wavelength at VHF frequencies and the transmitter was rich of harmonics.

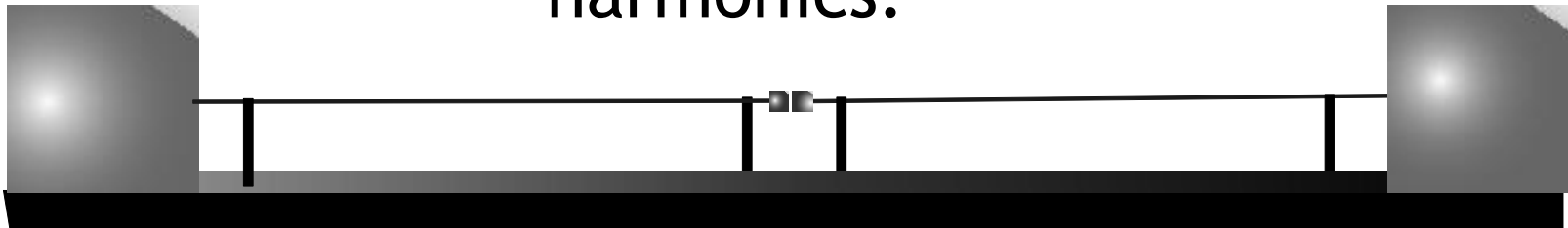

MODERN ANTENNAS

- ◉ Modern antennas often do not differ much from their ancestors in their outward appearance but are usually of highly elaborate design tailored to match the application on hand.
- ◉ In radio communication, we are trying to design the best possible transmit and receive antennas with sufficient bandwidth.

MODERN ANTENNAS...CONT.

- ◉ For test antennas, which serve to provide a test receiver with an exact measure of the field strength at the antenna site, this requirement is of little importance. In this case it is essential that the physical characteristics of the antenna are exactly known.
- ◉ The direction of energy conversion is irrelevant as far as the principle of operation and the understanding thereof are concerned.
- ◉ The transmitting and the receiving antenna can be looked at in the same way, as per reciprocity principle, and the parameters are equally valid for transmission and reception.

PASSIVE ANTENNAS

- Passive antennas can be used for both transmit and receive but as they are typically aperiodic need a matching circuit. This means that the reactive value is made resonant at the operational frequency and the resistive element (combination of radiation resistance and loss resistance) are matched into 50 ohms. This is a typical value in radio equipment.

ACTIVE ANTENNAS

- ◉ While passive antennas with antenna tuners are frequency selective, active antennas can be operated over a wide frequency range.
- ◉ The typical active antenna is a voltage probe with an electrical length much less than quarter length.
- ◉ The voltage supplied from this voltage probe is fed to an active circuit with minimum loading of the probe and the power gain comes from transforming very high impedance to low impedance maintaining the same voltage.
- ◉ A typical frequency range is 9KHz to 80MHz for a 1 meter length voltage probe.

ANTENNA PARAMETERS

- ◉ **Isotropic Radiator (Point Source):** Uniform radiation in all directions would be obtained only with an isotropic radiator, which can however not be realized for a particular polarization and is therefore suitable as a model or reference standard.

Radiation pattern from Isotropic antenna

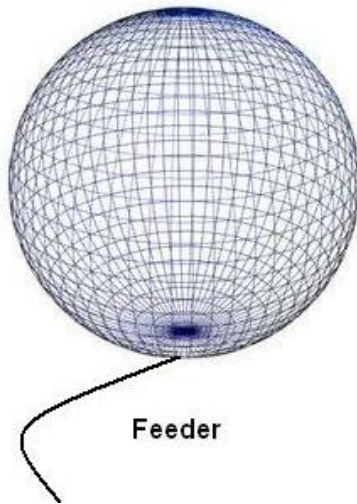

- ◉ **Radiation Pattern:** The spatial radiation of antennas is described by means of radiation patterns (usually in the far field).

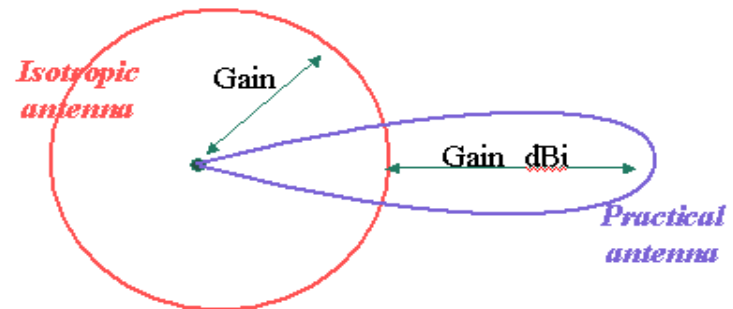

- ◉ While dipoles (2.2dB gain over the isotropic radiator) and monopoles do have some directivity, the term directional antennas is only used for antennas with radiation focused in a specific direction.

RADIATION

- There are two types of radiations
- E-field (Voltage)
- H-field (Current)
- Voltage is the major cause of interference



(a) Dipole Antenna Model

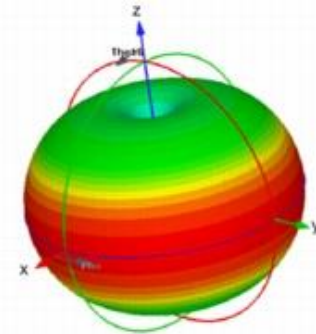

(b) Dipole 3D Radiation Pattern

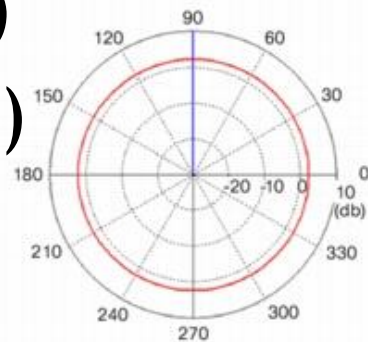

(c) Dipole Azimuth Plane Pattern

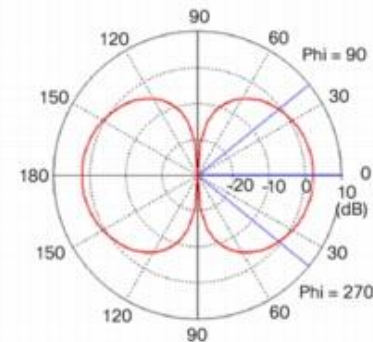

(d) Dipole Elevation Plane Pattern

CURRENT TRANSMITS
VOLTAGE NUSIANCE

ANTENNA RADIATION PATTERN

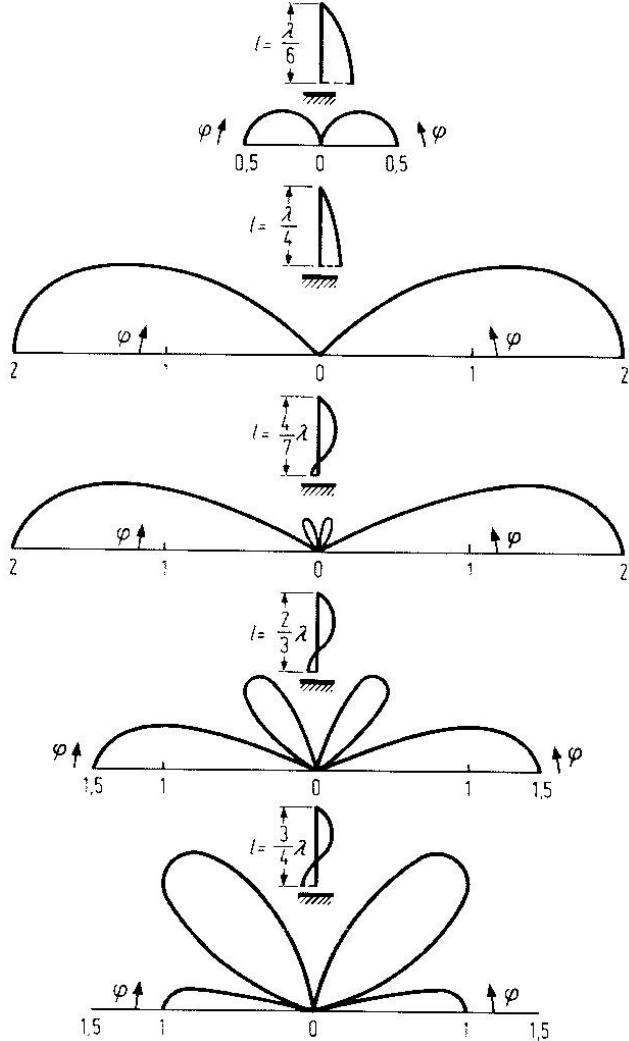

ANTENNA RADIATION PATTERN

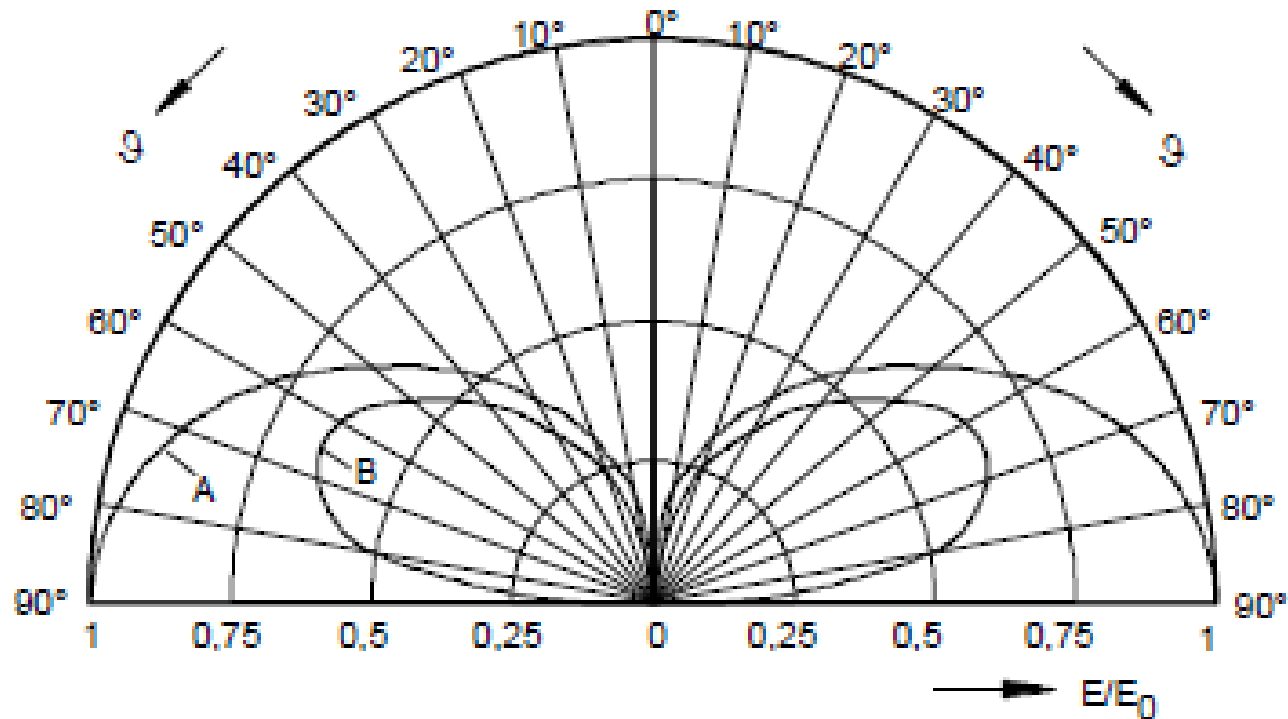

Radiation pattern of vertical monopole above ground of perfect (A) and average (B) conductivity

DIRECTIVITY FACTOR

- ◉ The directivity factor D is defined as the ratio of the radiation intensity F_{\max} obtained in the main direction of radiation to the radiation intensity F_i that would be generated by a loss-free isotropic radiator with the same radiated power P_t
- ◉ The power density is measured at the same distance r from the antennas

The radiation intensity can be replaced by the power density represented by the Poynting vector as shown below:

$$\underline{S} = \underline{E} \times \underline{H}$$

With \underline{S} perpendicular to \underline{E} and

\underline{S} and \underline{E} perpendicular to \underline{H} in the far field

$$D = F_{\max} / F_i, \text{ where } F_i = Pt / 4\pi$$

(characters in bold and underlined characters in the above formula and in the following indicate vectors).

EFFECTIVE AREA

- The effective area A_w of an antenna is a parameter specially defined for receiving antennas. It is a measure for the maximum received power $P_{r\max}$ that an antenna can pick up from a plane wave of the power density S .
- The effective area of an antenna can be converted to the gain and vice versa by means of the formula

$$A_w = \frac{\lambda^2}{4\pi} \bullet G$$

$$P_{r\max} = S \cdot A_w$$

$$q = A_w / A_g$$

EFFECTIVE AREA...CONT.

- The relationship between the effective and the geometrical areas is described by the **aperture efficiency**
- Make sure that the effective area matches the wavelength or multiples of it.
- Although the effective area of an antenna can well be conceived as a real area perpendicular to the direction of propagation of the incident wave, it is not necessarily identical with the geometrical area A_g of the antenna.

EFFECTIVE ANTENNA LENGTH

- Analogous to the effective area of the antenna, the effective antenna length (often also referred to as effective antenna height) is the quotient of the maximum open-circuit voltage V_0 at the antenna terminals and the electric field strength E of the incident, linearly polarized wave obtained with the antenna optimally aligned.

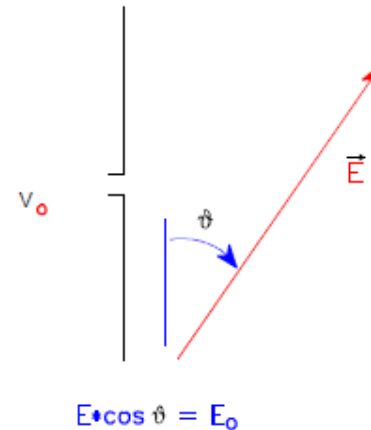

$$V_0 = \frac{E \cos \vartheta}{\pi} \lambda \sqrt{\frac{R_A \cdot G}{120\Omega}}$$

$$E \cos \vartheta = E_0$$

$$l_{eff} = V_0 / E_0$$

$$V_0 = h_{eff} \cdot E_0 = l_{eff} \cdot E_0$$

EFFECTIVE ANTENNA LENGTH

- ⦿ For a very thin half-wave dipole, $l_{\text{eff}} = 0.64 \times l$ is obtained, for example. From this, the effective length can well be illustrated.
- ⦿ The effective length of an antenna is the length required for a dipole to which a homogeneous feedpoint current I_A is applied to generate the same field strength in the main direction of radiation as a radiator to which the actual current is applied.

EFFECTIVE ANTENNA LENGTH

- The effective antenna length is not identical with the geometrical antenna length.
- The effective length can be calculated from the geometrical length l_g of the antenna and the current distribution $I(z_q)$ on the antenna during transmission by evaluating the integral.
- To convert power-referred into voltage-referred quantities, the formula can be used if the feed-point impedance R_A of the antenna is known.

$$l_{eff} = \int_0^{l_g} \frac{I(z_q)}{I_A} dz_q$$

$$l_{eff} = 2R_A A_{w120p} W$$

ANTENNA FACTOR

- Unlike the effective length, the antenna factor K is the quotient of the electric field strength E and the voltage V_{IN} present at the matched receiver input.

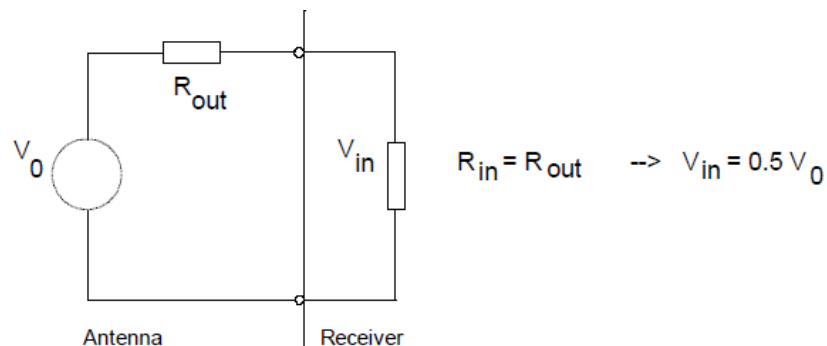

$$K = \frac{\text{Electric field strength}}{\text{Output Voltage into termination}}$$

Power Matching / Complex Conjugates

RADIATION RESISTANCE

- The radiation resistance is defined by,

$$R_s = 60.\pi^2 \left(\frac{h_{eff}}{\lambda} \right)^2 \Omega$$

where, h_{eff} – effective antenna height

- Thus for a $\lambda/4$ dipole antenna

$$R_s \cong 37 \Omega$$

- Thus for a $\lambda/2$ dipole antenna

$$R_s \cong 73 \Omega$$

FEED-POINT RESISTANCE \neq RADIATION RESISTANCE ???

- Feed-point resistance in general is NOT EQUAL to radiation resistance.

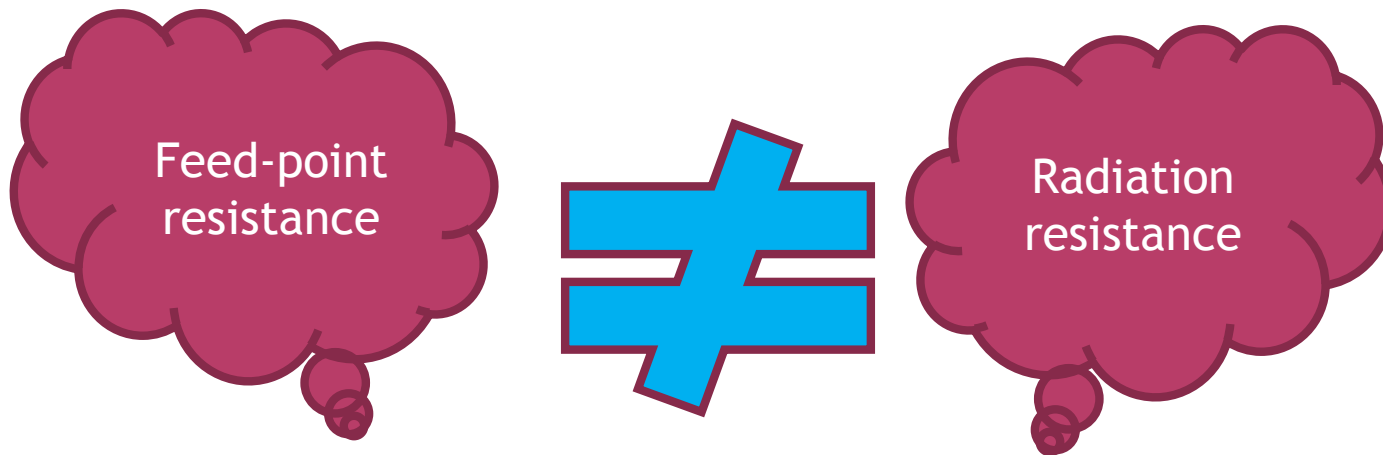

- But changing the feeding point of the antenna this can be made to be SAME.

DEFINITION-RADIATION RESISTANCE

- The resistive part of an antenna's feed-point impedance that is *created solely by radiation from the antenna*.
- The total power radiated in all directions divided by the square of maximum net (or effective) current causing the radiation
- The characteristics of wire antenna is given by Z in open space.

$$Z = \sqrt{\frac{\mu_0}{\epsilon_0}} \Omega = \sqrt{\frac{4\pi \cdot 10^{-7}}{8.854 \cdot 10^{-12}}} \Omega$$

$$Z = 376.99 \cong 377 \Omega$$

- The assumption is the wire is thin as compared to the length. In the case of thick antennas ($L=4 \cdot \text{Diameter}$ (D)) the impedance approaches rapidly 150ohms.

RADIATION RESISTANCE VERSES WAVELENGTH

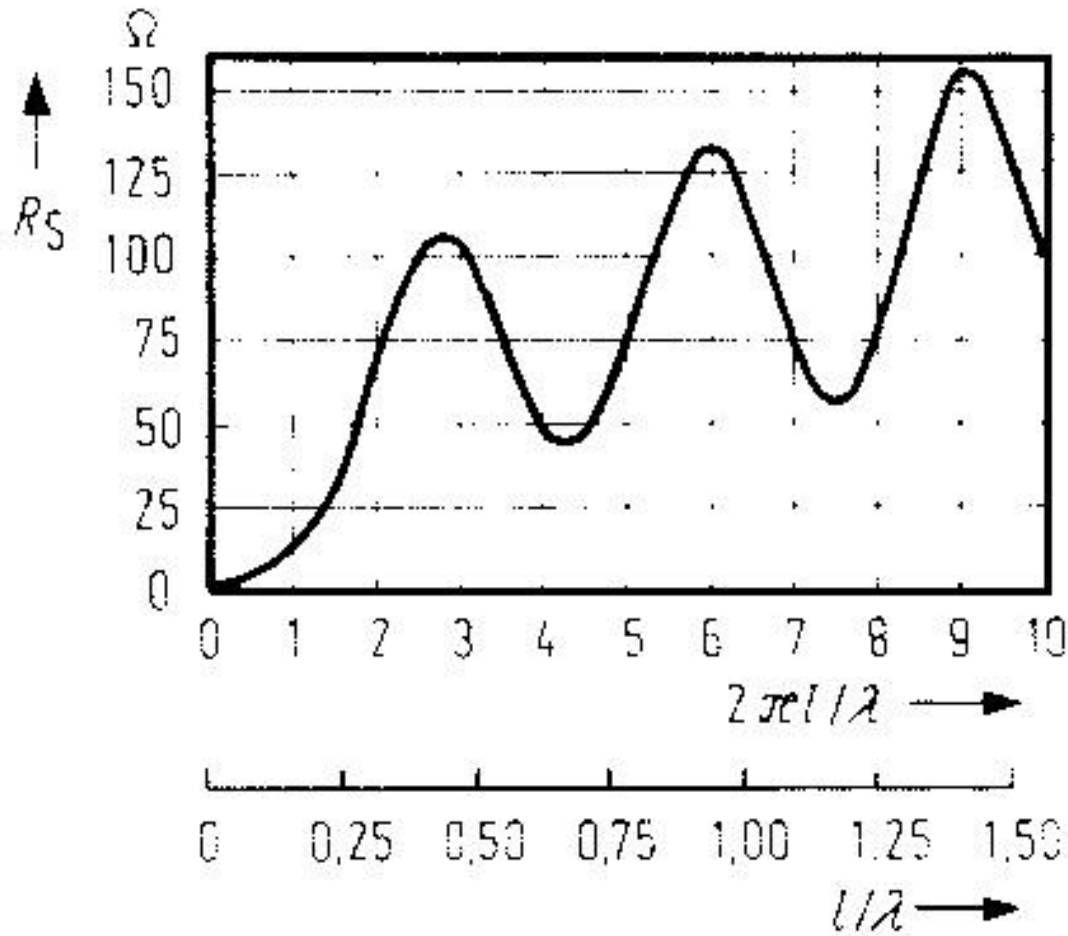

ELECTRICAL EQUIVALENT OF A ELECTRICALLY SHORT ANTENNA

$$C_a = \frac{0.24 \times l}{\log\left(\frac{1.15 \times l}{D}\right)} [pF], \text{ where } C_a - \text{Equivalent capacitance}$$

of the antenna

R_F – the input - output impedance of $\lambda/4$ antenna

Z_a - is the characteristic impedance of the wire

$$R_F = \frac{Z_a^2 + jR_s \cdot Z_a \tan\left(2\pi \frac{l}{\lambda}\right)}{R_s + jZ_a \tan\left(2\pi \frac{l}{\lambda}\right)} \Omega$$

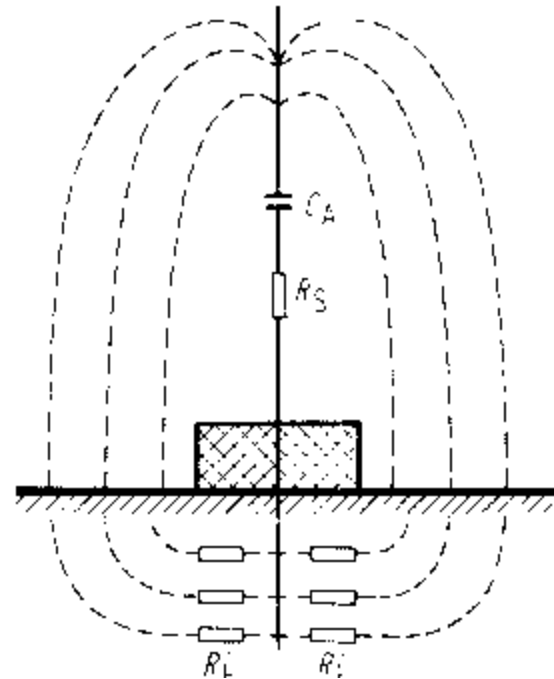

Fields from dipole antenna showing capacitor and resistor with ground losses

SLOT ANTENNA

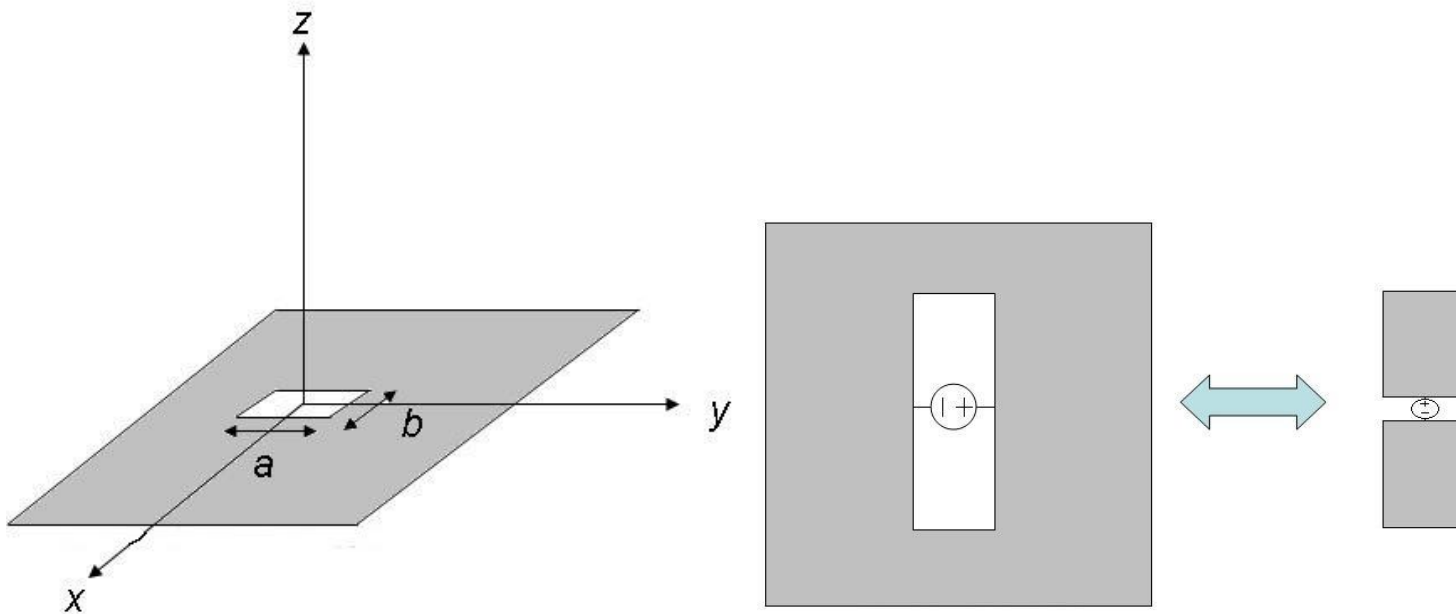

Difficult to match because of
low impedance

LOOP ANTENNA



- Receives the H-field
- It receives less static noise as compared to the Vertical antenna

EFFICIENCY OF ANTENNA



- Radiation efficiency

$$\text{Efficiency, } \eta = \frac{R_s}{R_s + R_e}, \text{ where } R_s \text{ – radiation resistance}$$



R_e – loss in antenna and ground

- When the loss in the antenna and ground is zero Efficiency is 100%

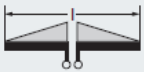
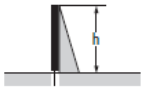
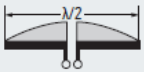
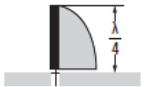
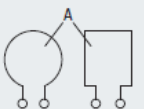
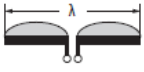
PARAMETERS OF SELECTED ANTENNAS

Type of antenna	Current distribution	Directivity factor D ⁵⁾	Effective antenna length	Radiation resistance R in Ω	Field strength in direction of maximum radiation ⁶⁾ in mV/m	
Isotropic radiator		$1 \triangleq 0$ dB			$\sqrt{30} \cdot \frac{\sqrt{P/W}}{r/\text{km}}$	$173 \cdot \frac{\sqrt{P/kW}}{r/\text{km}}$
Hertz dipole with end capacitance ⁷⁾		$1.5 \triangleq 1.8$ dB	l	$80 \pi^2 \left(\frac{l}{\lambda}\right)^2$	$3 \cdot \sqrt{5} \cdot \frac{\sqrt{P/W}}{r/\text{km}}$	$212 \cdot \frac{\sqrt{P/kW}}{r/\text{km}}$
Short antenna on infinitely conducting ground with top capacitance ⁸⁾		$3 \triangleq 4.8$ dB	h	$160 \pi^2 \left(\frac{h}{\lambda}\right)^2$	$3 \cdot \sqrt{10} \cdot \frac{\sqrt{P/W}}{r/\text{km}}$	$300 \cdot \frac{\sqrt{P/kW}}{r/\text{km}}$
Short dipole without end capacitance ⁷⁾		$1.5 \triangleq 1.8$ dB	$\frac{l}{2}$	$20 \pi^2 \left(\frac{l}{\lambda}\right)^2$	$3 \cdot \sqrt{5} \cdot \frac{\sqrt{P/W}}{r/\text{km}}$	$212 \cdot \frac{\sqrt{P/kW}}{r/\text{km}}$
Short antenna on infinitely conducting ground without top capacitance ⁸⁾		$3 \triangleq 4.8$ dB	$\frac{h}{2}$	$40 \pi^2 \left(\frac{h}{\lambda}\right)^2$	$3 \cdot \sqrt{10} \cdot \frac{\sqrt{P/W}}{r/\text{km}}$	$300 \cdot \frac{\sqrt{P/kW}}{r/\text{km}}$
Half-wave dipole		$1.64 \triangleq 2.15$ dB	$\frac{\lambda}{\pi}$	73.2	$7 \cdot \frac{\sqrt{P/W}}{r/\text{km}}$	$221 \cdot \frac{\sqrt{P/kW}}{r/\text{km}}$
Quarter-wave antenna on infinitely conducting ground		$3.28 \triangleq 5.2$ dB	$\frac{\lambda}{2\pi}$	36.6	$10 \cdot \frac{\sqrt{P/W}}{r/\text{km}}$	$316 \cdot \frac{\sqrt{P/kW}}{r/\text{km}}$
Small single-turn loop in free space		$1.5 \triangleq 1.8$ dB	$\frac{2\pi A}{\lambda}$	$80 \pi^2 \frac{4\pi^2 A^2}{\lambda^4}$	$3 \cdot \sqrt{5} \cdot \frac{\sqrt{P/W}}{r/\text{km}}$	$212 \cdot \frac{\sqrt{P/kW}}{r/\text{km}}$
Full-wave dipole		$2.4 \triangleq 3.8$ dB			$6 \cdot \sqrt{2} \cdot \frac{\sqrt{P/W}}{r/\text{km}}$	$268 \cdot \frac{\sqrt{P/kW}}{r/\text{km}}$

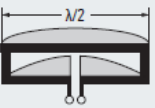
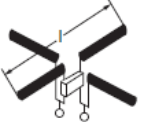
PARAMETERS OF SELECTED ANTENNAS CONT...

Type of antenna	Current distribution	Directivity factor D ⁵⁾	Effective antenna length	Radiation resistance R in Ω	Field strength in direction of maximum radiation ⁶⁾ in mV/m	
Folded half-wave dipole		1.64 ≅ 2.15 dB	$\frac{2\lambda}{\pi}$	4 · 73.2 ≅ 280	$7 \cdot \frac{\sqrt{P/W}}{r/\text{km}}$	$221 \cdot \frac{\sqrt{P/kW}}{r/\text{km}}$
Turnstile antenna (Hertz dipole) radiating in horizontal plane		0.75 ≅ 1.2 dB	l	$40 \pi^2 \left(\frac{l}{\lambda}\right)^2$	$\frac{3}{2} \cdot \sqrt{10} \cdot \frac{\sqrt{P/W}}{r/\text{km}}$	$150 \cdot \frac{\sqrt{P/kW}}{r/\text{km}}$
Broadside array (Hertz dipoles) (L ≫ λ)		$4 \cdot \frac{L}{\lambda}$			$2 \cdot \sqrt{30} \cdot \sqrt{\frac{l}{\lambda}} \cdot \frac{\sqrt{P/W}}{r/\text{km}}$	$346 \cdot \sqrt{\frac{l}{\lambda}} \cdot \frac{\sqrt{P/kW}}{r/\text{km}}$
Collinear array (Hertz dipoles) (L ≫ λ)		$2 \cdot \frac{L}{\lambda}$			$2 \cdot \sqrt{15} \cdot \sqrt{\frac{l}{\lambda}} \cdot \frac{\sqrt{P/W}}{r/\text{km}}$	$245 \cdot \sqrt{\frac{l}{\lambda}} \cdot \frac{\sqrt{P/kW}}{r/\text{km}}$
Antenna with directivity D		D			$\sqrt{30} \cdot \sqrt{D} \cdot \frac{\sqrt{P/W}}{r/\text{km}}$	$173 \cdot \sqrt{D} \cdot \frac{\sqrt{P/kW}}{r/\text{km}}$

IMPEDANCE MATCHING

- ⦿ In general the electrically short antenna has a low resistive (and capacitive impedance) feeding point impedance that needs to be matched to 50 Ω system
- ⦿ There are several ways to do so.
- ⦿ Antenna coupling network is a passive network (generally a combination of inductive and capacitive circuit elements).

THEORETICAL INPUT IMPEDANCE OF WHIP ANTENNA V/S FREQUENCY

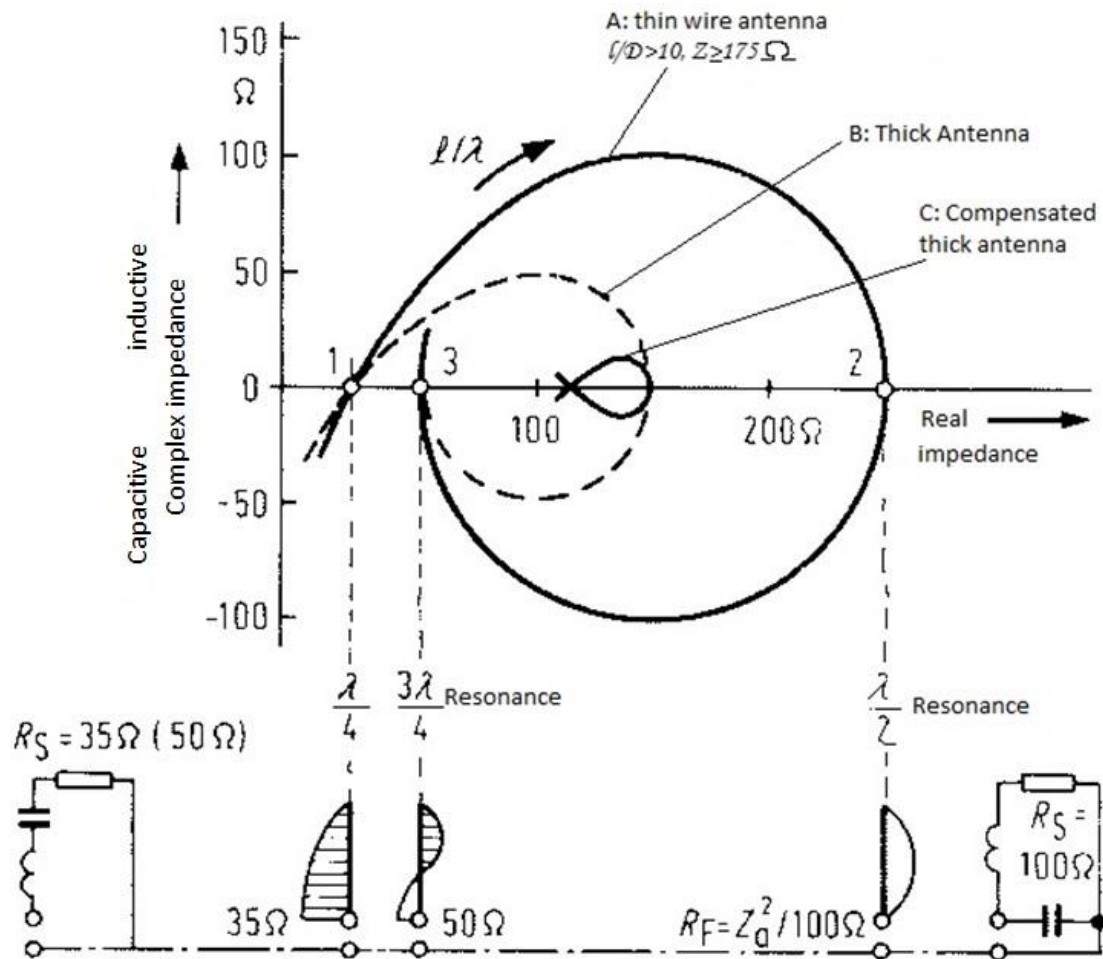

A 35-FT (10.67M) WHIP ANTENNA IMPEDANCE MEASURED (USED ON SHIP BOARD)

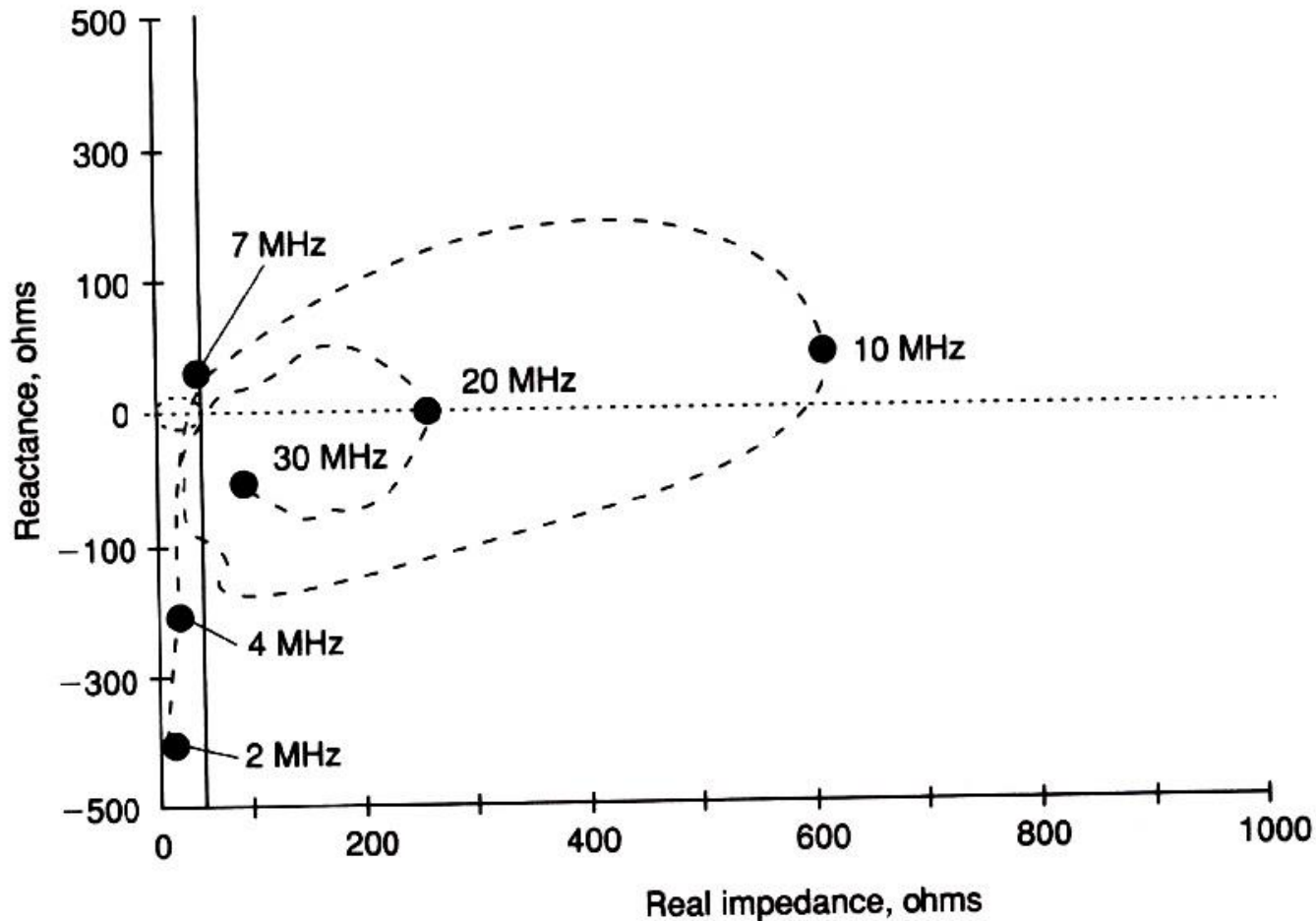

CHARACTERISTICS OF A 10.5-FOOT WHIP ANTENNA

F (MHz)	C (pF)	Radiation resistance (Ω)	Impedance (Ω)	Efficiency %	L (μ H)
1.8	30.1	0.146	13.72-j2716	1.064	240
3.5	30.6	0.55	7.43-j1375	7.4	62.5
7.0	32.8	2.2	7.04-j644	31.2	1406
10.0	36.5	4.5	6.5-j408	69.2	6.49
14.0	46.5	8.8	10-j232	88.0	2.64

AIRCRAFT SLOT ANTENNA IMPEDANCE MEASURED

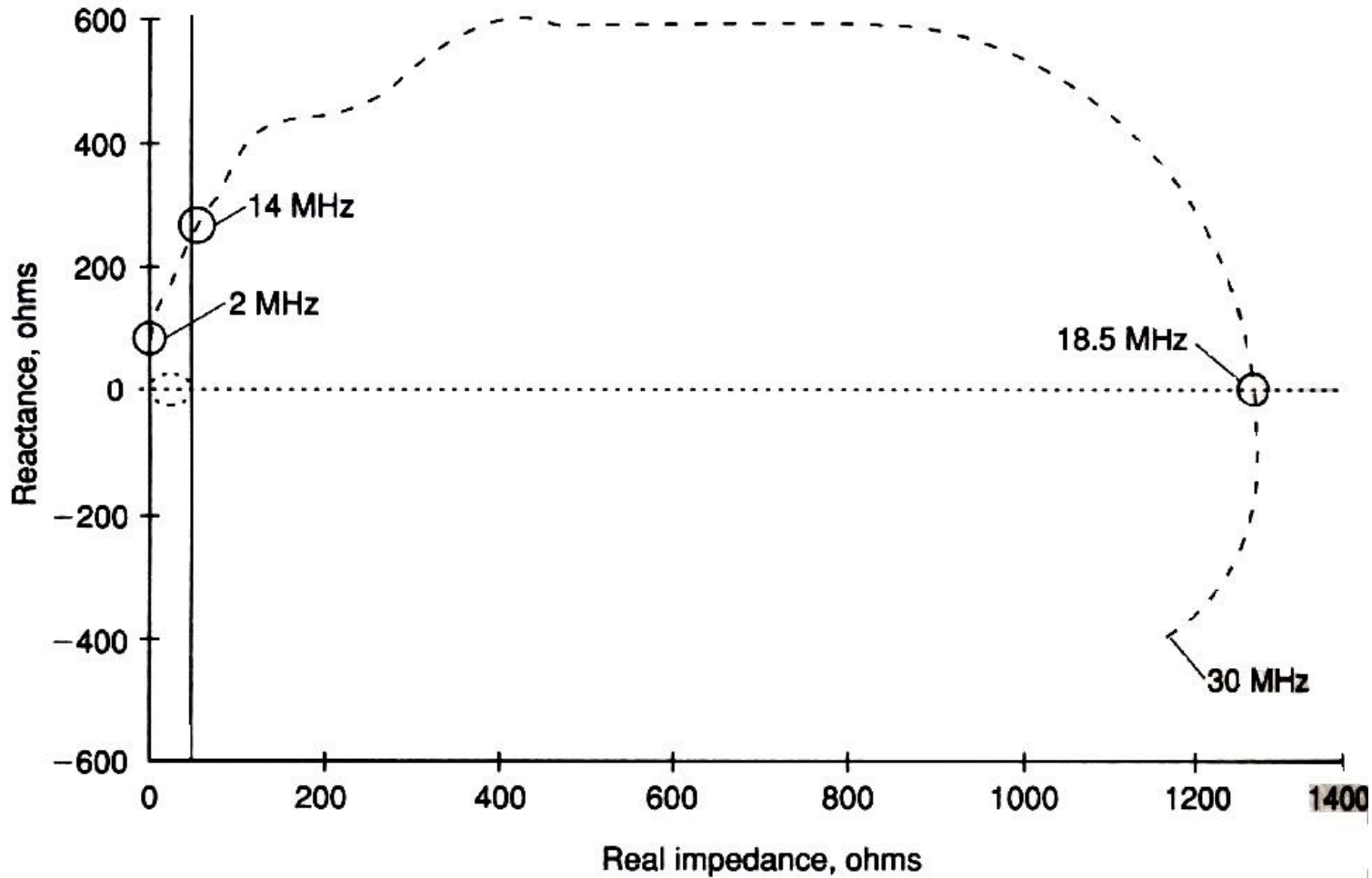

MATCHING TECHNIQUES

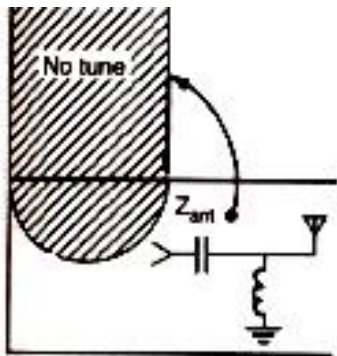

A

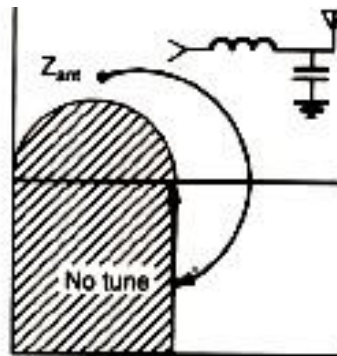

B

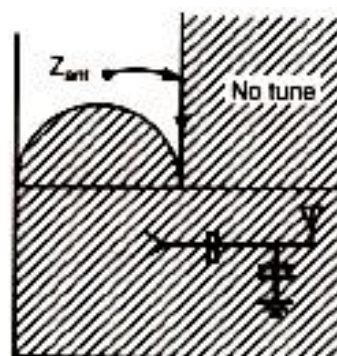

C

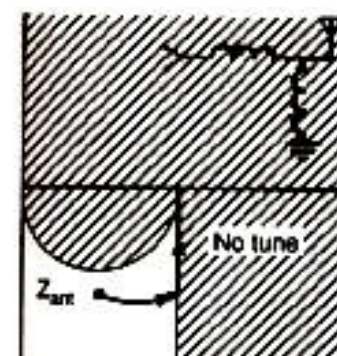

D

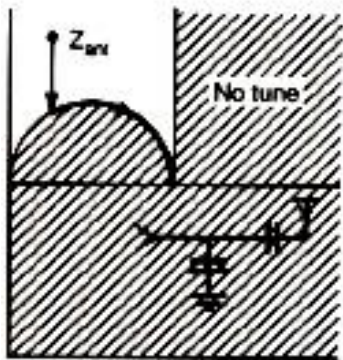

E

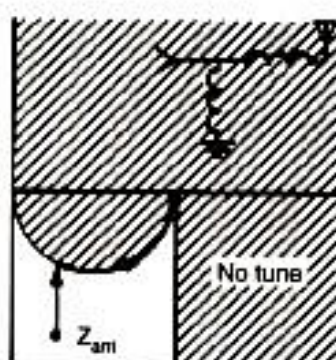

F

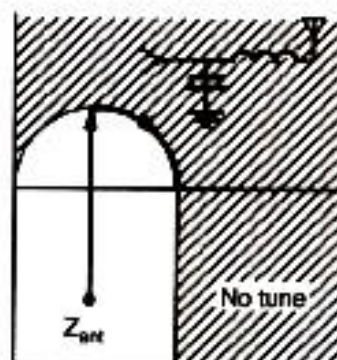

G

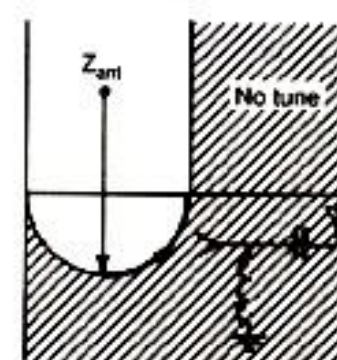

H

ANTENNA LOADING

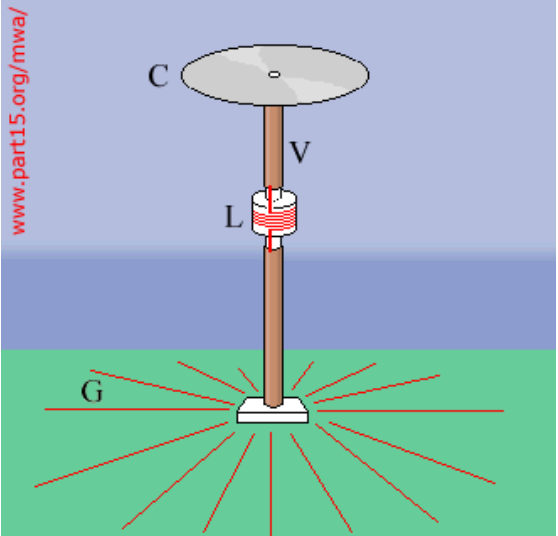

Capacitive-Inductive loading

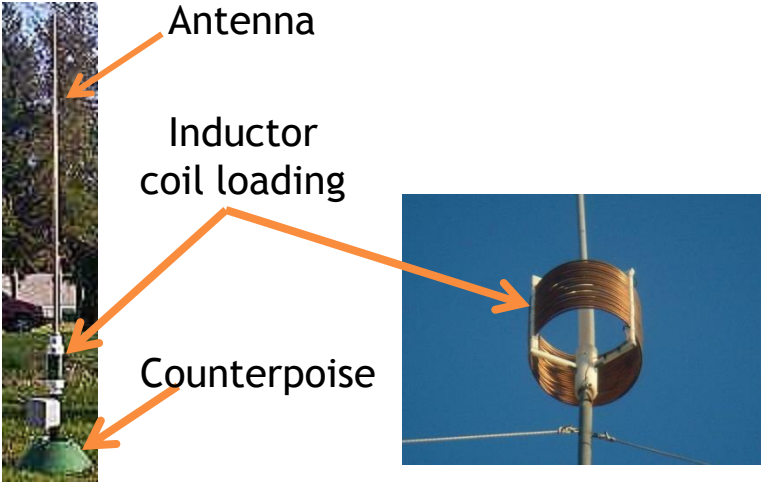

Inductive loading

3 TYPES OF VERTICAL (ELECTRICAL SHORT) ANTENNA

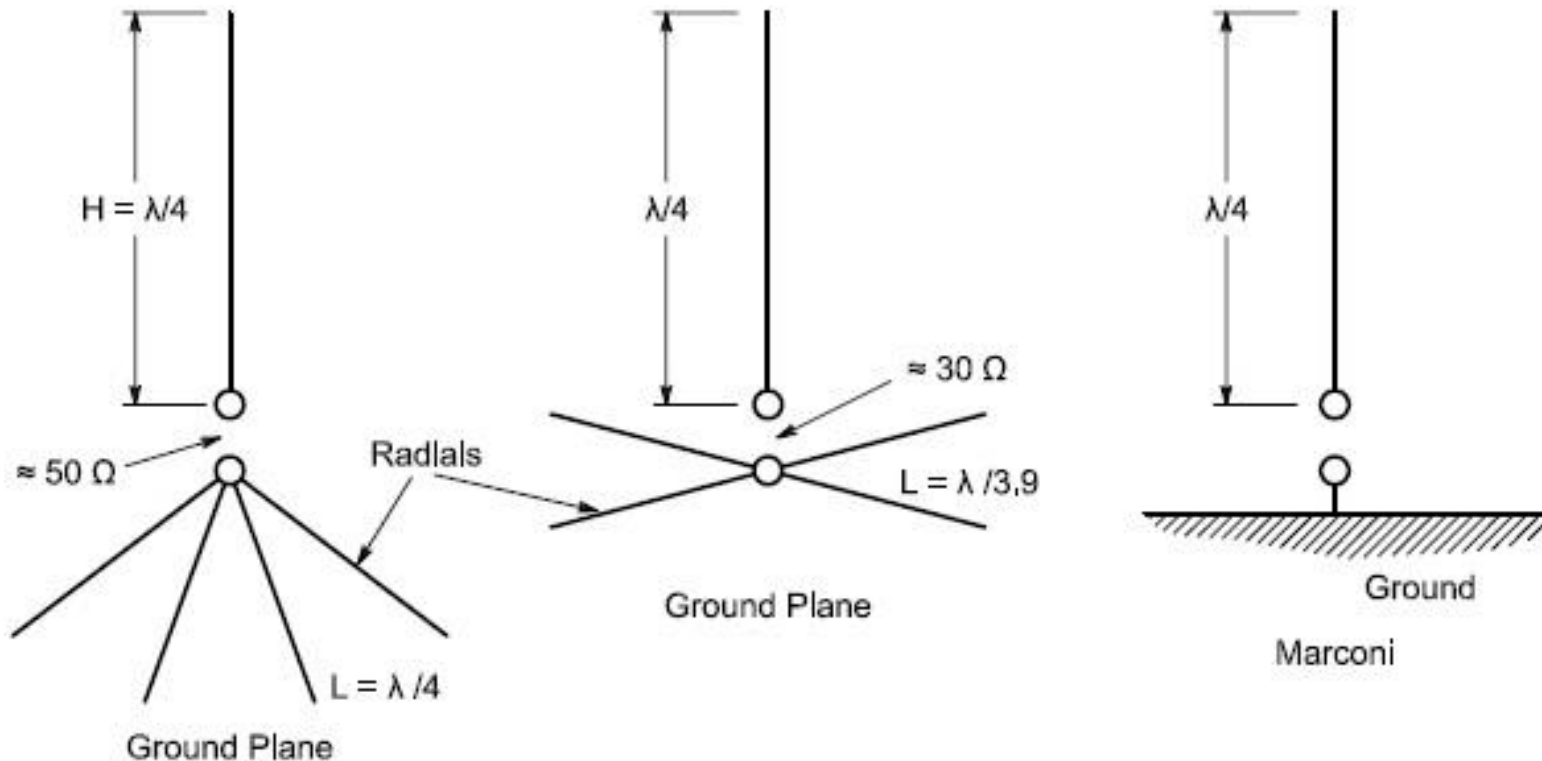

The angle of the radials is changed to match to 50Ω

COUNTERPOISE OR GROUND PLANE

- An antenna counterpoise or ground plane is a structure of (hopefully) conductive material which improves or substitutes for the ground. It may be connected to or insulated from the natural ground. In a monopole antenna, this aids in the function of the natural ground, particularly where variations (or limitations) of the characteristics of the natural ground interfere with its proper function. Such a structure is normally connected to the return connection of an unbalanced transmission line such as the shield of a coaxial cable.

CAPACITOR-INDUCTOR LOADED ANTENNA

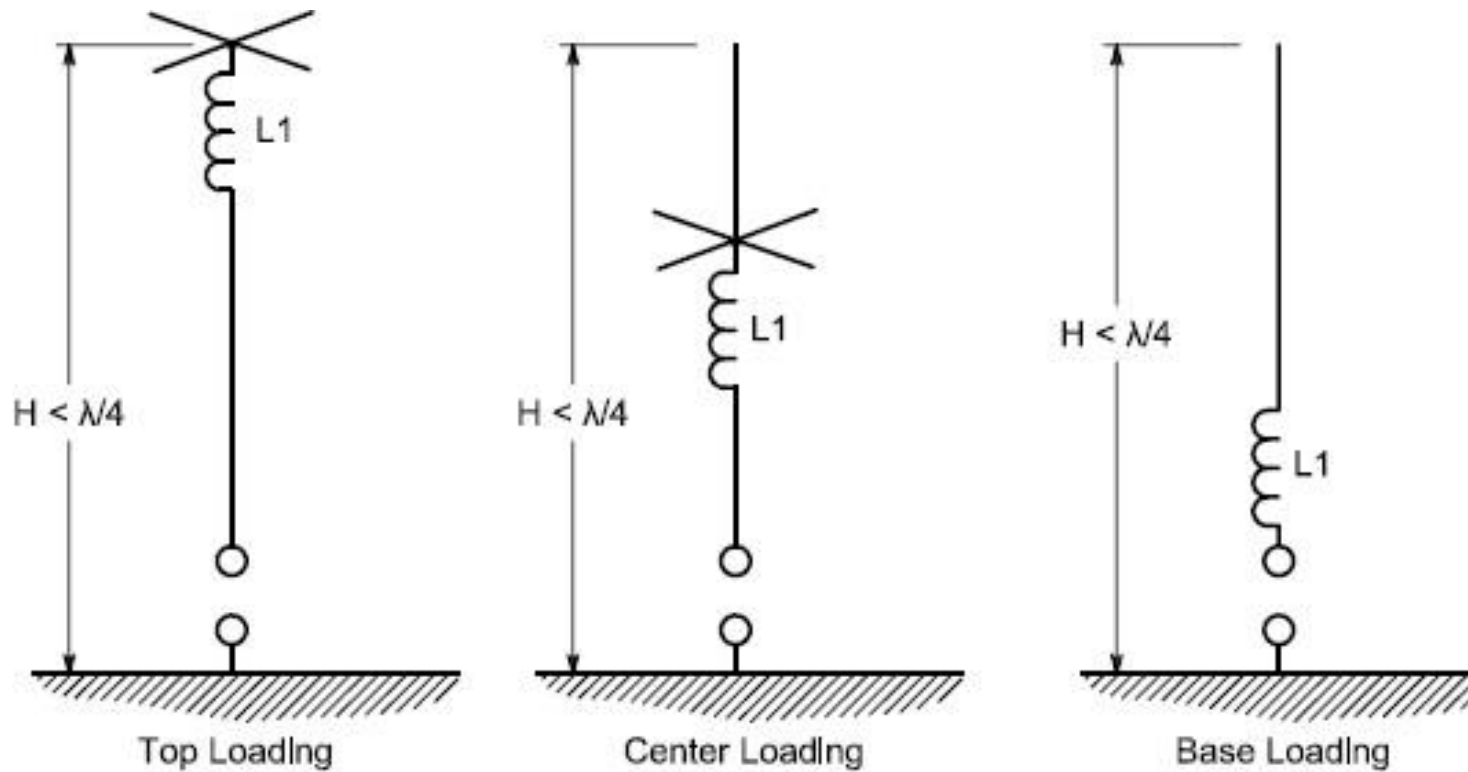

WHIP ANTENNA

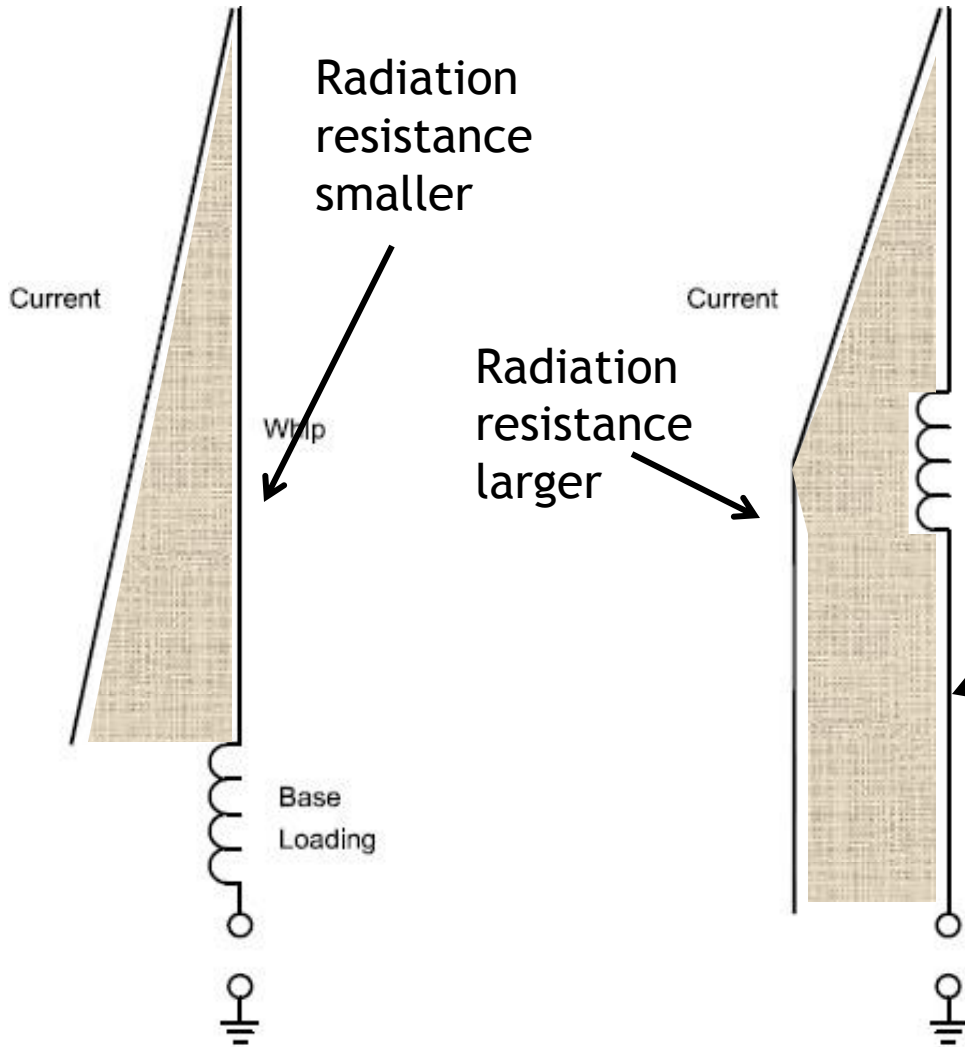

○ The larger the surface better the radiation

○ WHY??

○ The integrated surface is larger (Sketch NOT to scale)

THE MATCHING METHODOLOGY

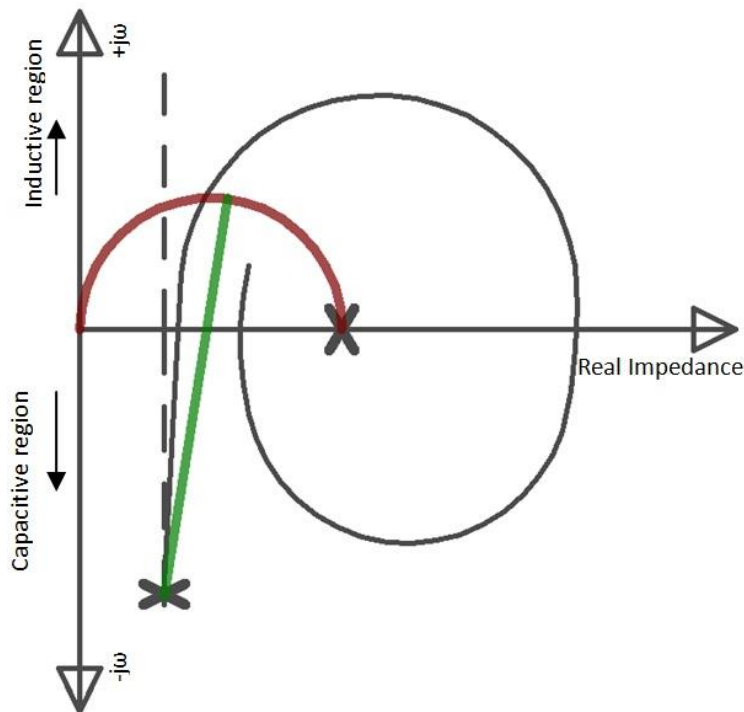

- The black curve represents the antenna impedance.
- The green line shows the value of inductance to choose
- The red curve gives the capacitance value needed to reach 50Ω

T OR PI NETWORK....

- The two element matching is the best.
WHY?? Least losses.
- Sometimes three element matching is used.
WHY?? More Efficient and wider tuning range,
binary coded.
- There are two types of 3-element circuit
used.
- A T-network (High pass filter) or a PI-network
(Low pass filter structure, if used for
impedance matching is called Collins filter
(Inventor))

THE T-MATCHING NETWORK

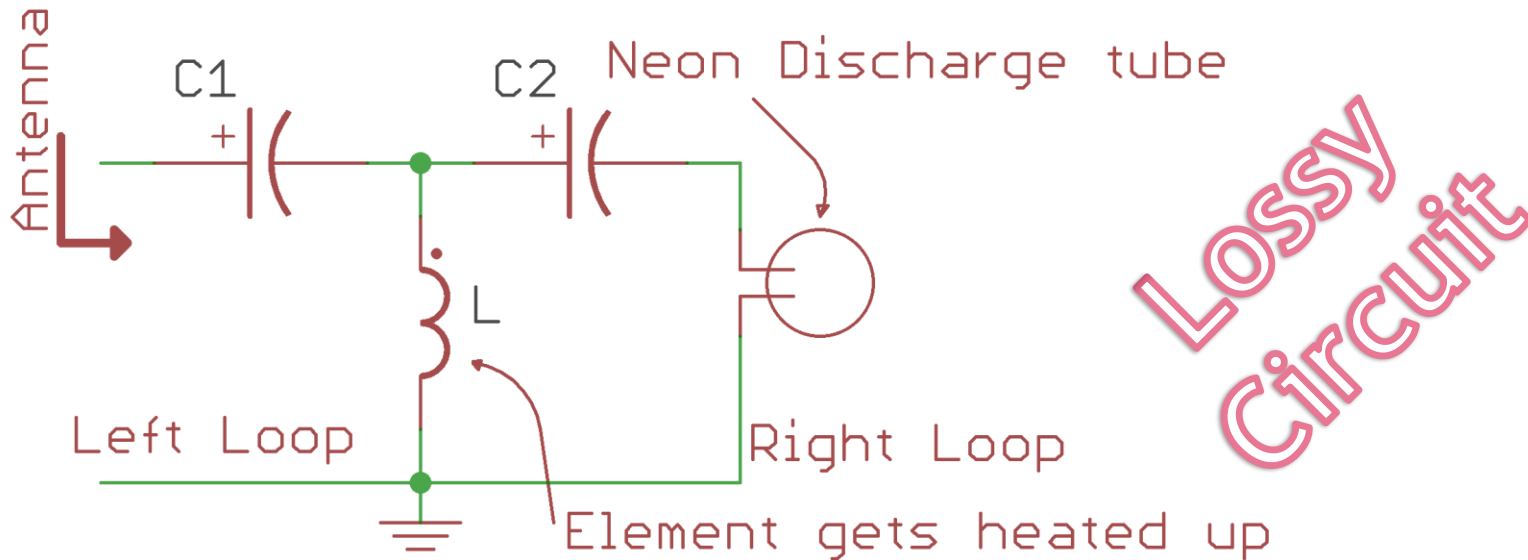

- The LC1 form one circuit and LC2 forms the other resonant structure and the two are tuned to get the resonance frequency
- Generally, when the value of C2 is too small, input resonance can occur but no loading and no output power is obtained. This is the flaw of this design

T NETWORK...CONT.

- ⦿ The T based high pass filter is mathematically over de-termed. The left loop and the right loop are dependent.
- ⦿ The left loop can be in perfect resonance and no output power (voltage) is available in the right loop.
- ⦿ The neon discharge tube glows when there is maximum voltage at the output of capacitor C2. (If $F_{out} < 30\text{MHz}$ blue color emitted and $F_{out} > 30\text{MHz}$ the pinkish color is emitted)
- ⦿ This configuration is also **LOSSY**, but unfortunately still **POPULAR!!**

THE PI MATCHING NETWORK- COLLINS FILTER

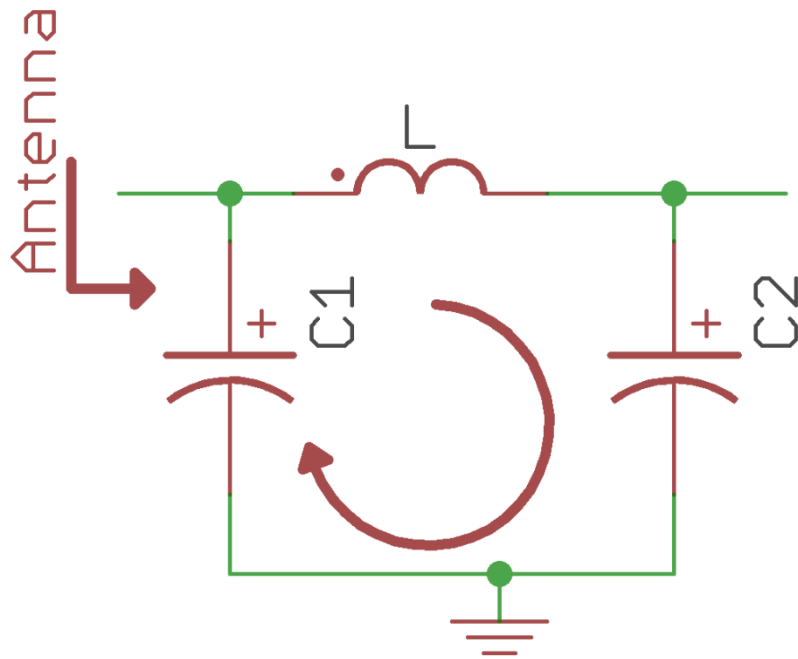

- The entire network $C1$ $C2$ and L determines the resonant frequency given by the following equations.
- Depending on the impedance the input and the output ports are exchangeable.

A PI MATCHING BASIC DESIGN EQUATIONS

$$Q_0^2 > \frac{R_1}{R_2} - 1 \text{ and } Q_0^2 > \frac{R_2}{R_1} - 1$$

where R_1 is the I/p resistance to be matched in Ohms

R_2 is the O/p (load) resistance to be matched in Ohms

Input Q is given as Q_1 :

$$Q_1 = \frac{R_1 Q_0 - \sqrt{R_1 R_2 Q_0^2 - (R_1 - R_2)^2}}{R_1 - R_2}$$

EXAMPLE PI MATCHING WITH REAL VALUES

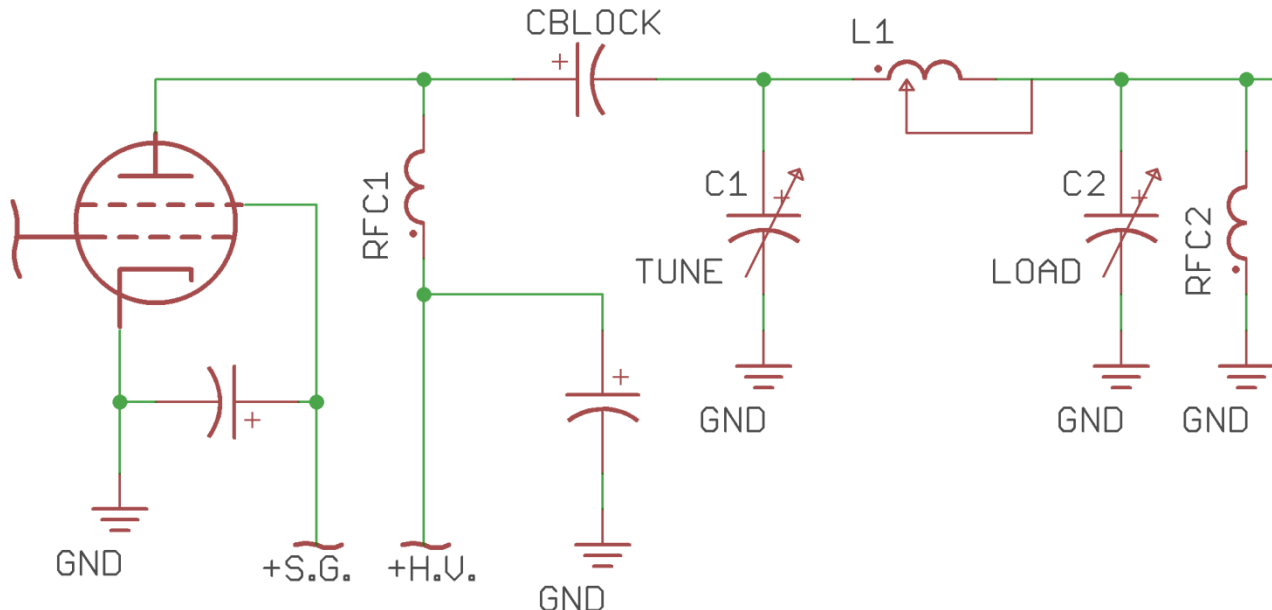

Let us select $Q_0 = 12$, $R_1 = 1500\Omega$, and $R_2 = 50\Omega$

$$Q_1 = \frac{1500 \times 12 - \sqrt{1500 \times 50 \times 12^2 - (1500 - 50)^2}}{1500 - 50}$$

$$Q_1 = 10.38$$

next calculate the value of output Q

EXAMPLE CONT...

$$Q_2 = Q_0 - Q_1$$

$$Q_2 = 12 - 10.38 = 1.62$$

next calculate the reactance of input and output capacitor, inductor

$$XC_1 = \frac{R_1}{Q_1} = 144.5\Omega \quad XC_2 = \frac{R_2}{Q_2} = 30.86\Omega \quad XL = \frac{R_1 Q_0}{Q_1^2 + 1} = 165.5\Omega$$

Finally calculate the value of components

$$C_1 = \frac{1}{2\pi f XC_1}, \text{ where } f \text{ is in Hz and } XC_1 \text{ is calculated in Ohms}$$

for this example the f is assumed to be 3.75MHz

$$C_1 = 294 \text{ pF}, \text{ Similarly,}$$

$$C_2 = \frac{1}{2\pi f XC_2} = 1375 \text{ pF}, \text{ and } L = \frac{XL}{2\pi f} = 7.02 \mu\text{H}$$

EXAMPLE SIMULATED IN ANSOFT DESIGNER 8

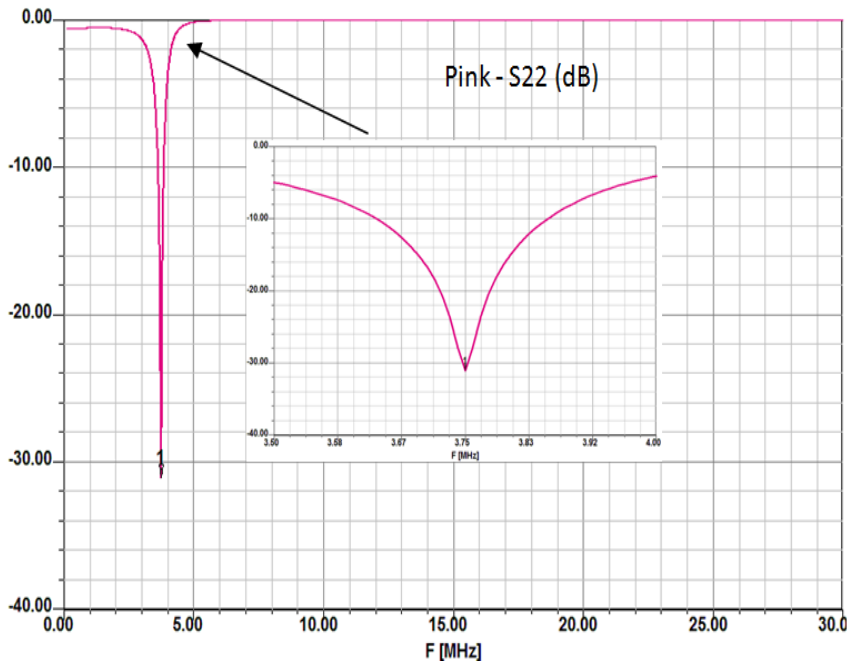
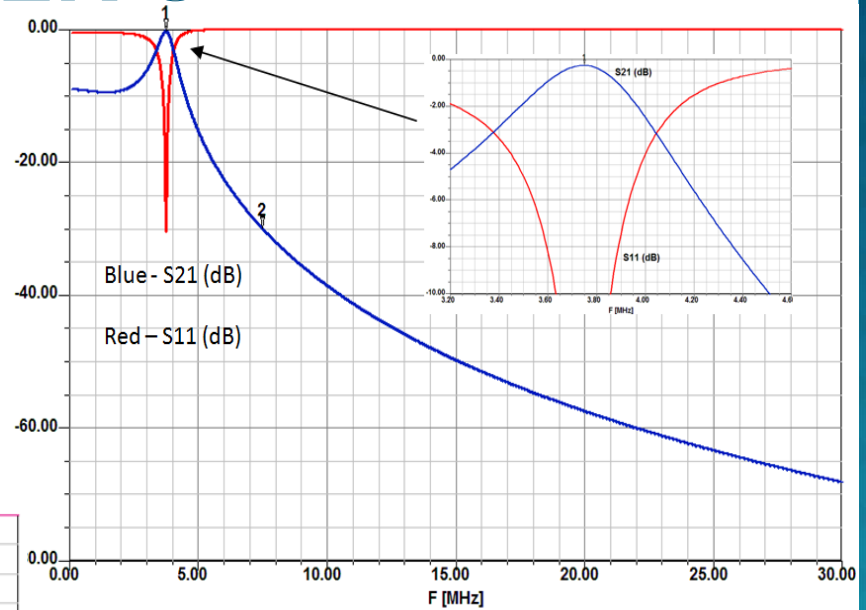
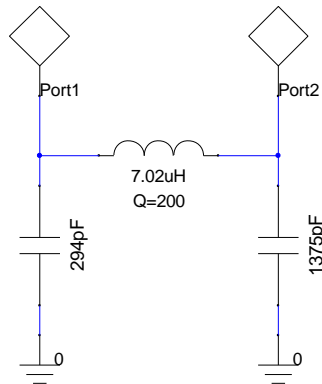

1970 PROTOTYPE ANTENNA TUNER BY ULRICH L. ROHDE

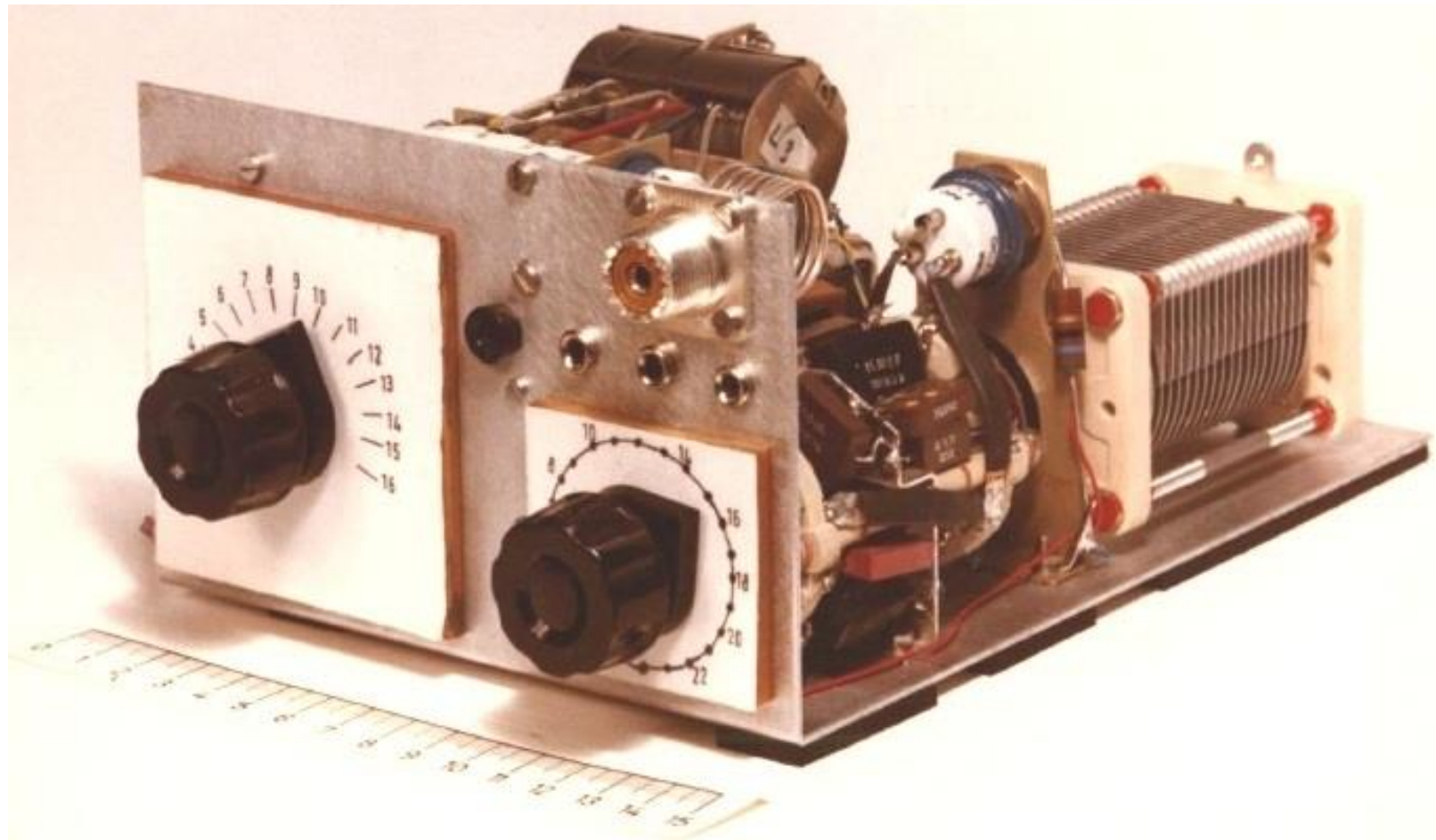

FAN ANTENNA

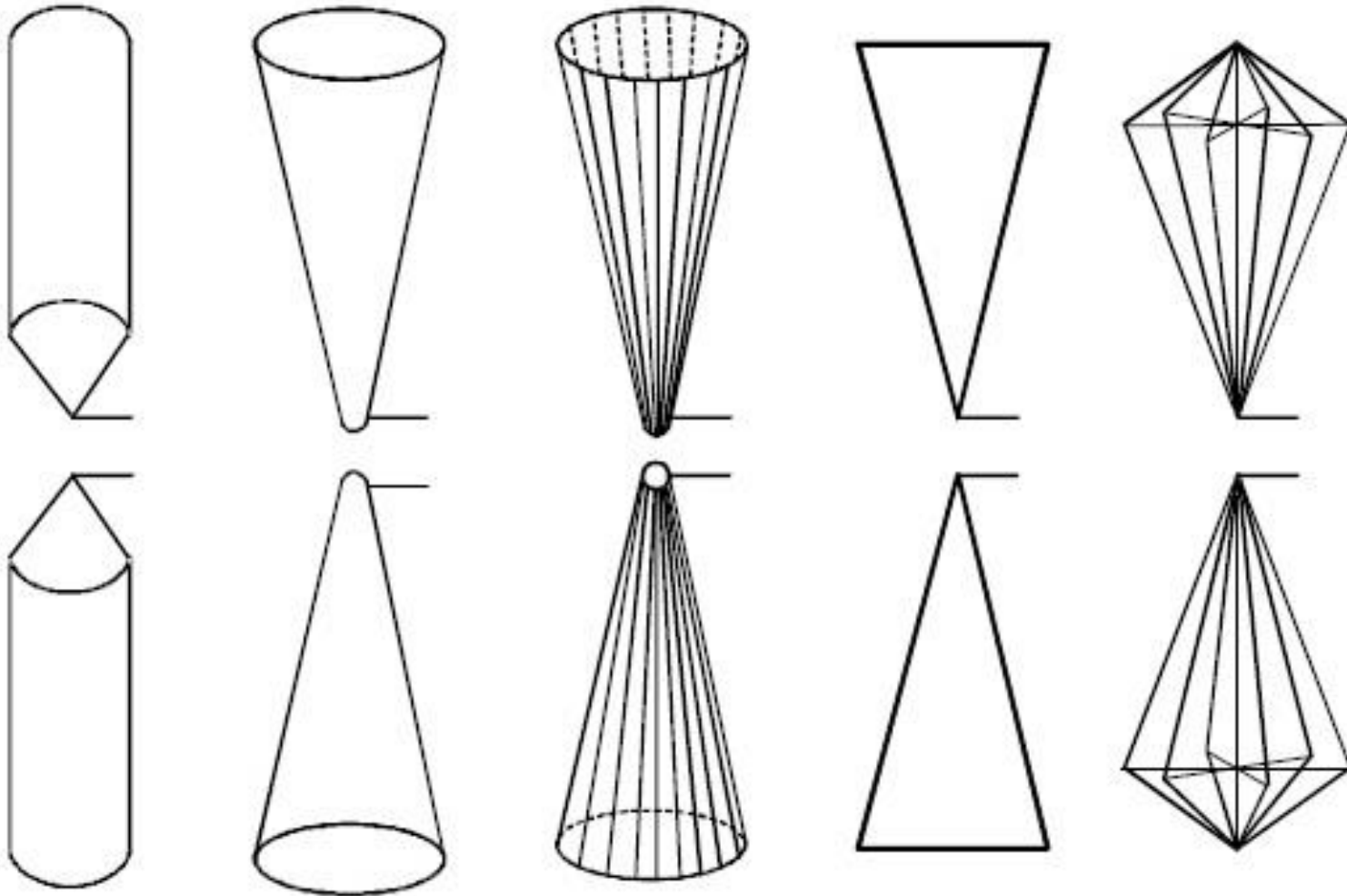

Can be the basis for Active Antenna Structures

NOW WE GO TO ACTIVE ANTENNAS



The picture shows Passive and Active antennas placed on top of a roof.

ACTIVE ANTENNAS

WHAT ARE ACTIVE ANTENNAS?

- ⦿ Active antennas are the only exception: being pure receiving antennas, they are non-reciprocal.
- ⦿ In its primitive form it is a source follower using a microwave power FET
- ⦿ Apart from that, a clear distinction between transmitting and receiving antennas must be made if, for example, the maximum transmitter power is to be taken into account. This is however irrelevant to the characteristics and the principle of operation
- ⦿ By connecting active devices directly to small receiving antennas, it is possible to achieve similar performance over a wide frequency range. Such circuit and antenna arrangements are referred to as active or a-periodic antennas.

SOME HISTORICAL BACKGROUND

- ◉ Copeland and Robertson demonstrated a mixer-integrated antenna using a tunnel diode, which they describe as an “antennaverter”. They also used a travelling wave antenna, together with tunnel diodes, to operate as a travelling wave amplifier, which they called an “antennafier” in 1961.
- ◉ H. Meinke introduced thoughts about actual transistorized receiving antennas.
- ◉ In 1971, H. Lindenmeier firstly addressed and described the integration of FET and antennas for reception
- ◉ In 1976, H. Lindenmeier introduced the general theory behind the optimum bandwidth of signal-to-noise ratio of receiving systems with small antennas
- ◉ Automotive applications based active antennas has been studied and extended by H.Lindenmeier
- ◉ Various car manufacturers have taken active antennas introduced by Lindenmeier, Meinke etal., into series production since 1982.

ACTIVE ANTENNAS

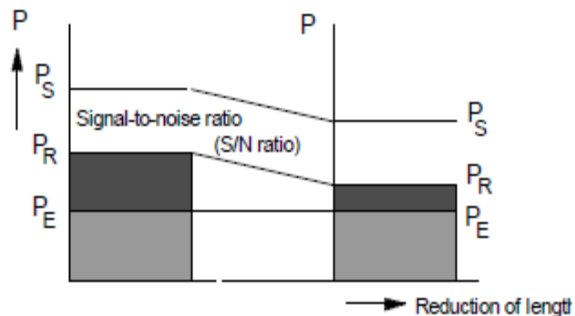
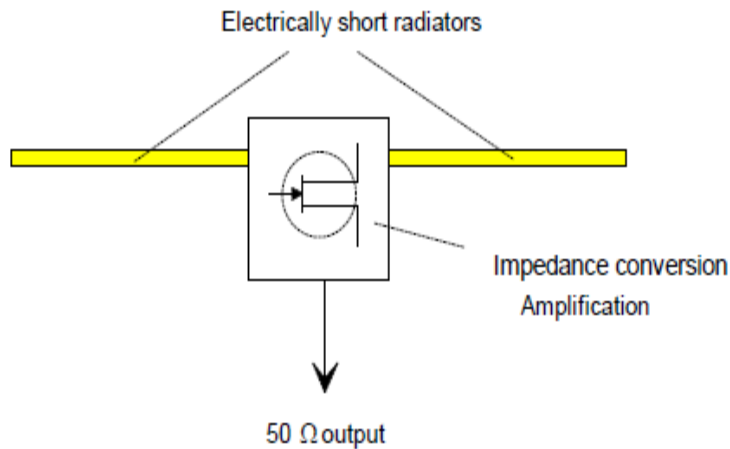

- Active antennas are another type of antenna that can be designed for broadband operations.
- They are based on the idea that a drastic reduction of the radiator length results in a corresponding reduction of the output voltages both of useful and interfering signals. Consequently, the signal-to-noise ratio (S/N ratio), which solely determines the reception quality, remains constant over a wide range

ACTIVE ANTENNAS CONT'D...

- ⦿ The extremely large impedance change resulting from this shortening (is compensated by applying the antenna terminal voltage directly to an active component (usually an FET) of very high impedance that acts as an impedance converter and often as an amplifier, too. Active antennas are thus by definition antennas in which an **active element is provided directly at the radiators.**
- ⦿ They must not be confused with systems in which the output signal of a passive antenna is looped through an amplifier in the mast.
- ⦿ An advantage in active antennas is the fact that as a result of the shortened radiators the radiation pattern is no longer frequency-dependent. Moreover, by carefully matching the electronic circuitry to the antenna geometry and by some additional measures, the antenna factor too can be made largely independent of frequency, so that field strength measurements can be performed very conveniently

ACTIVE RECEIVING DIPOLE ANTENNA HE202

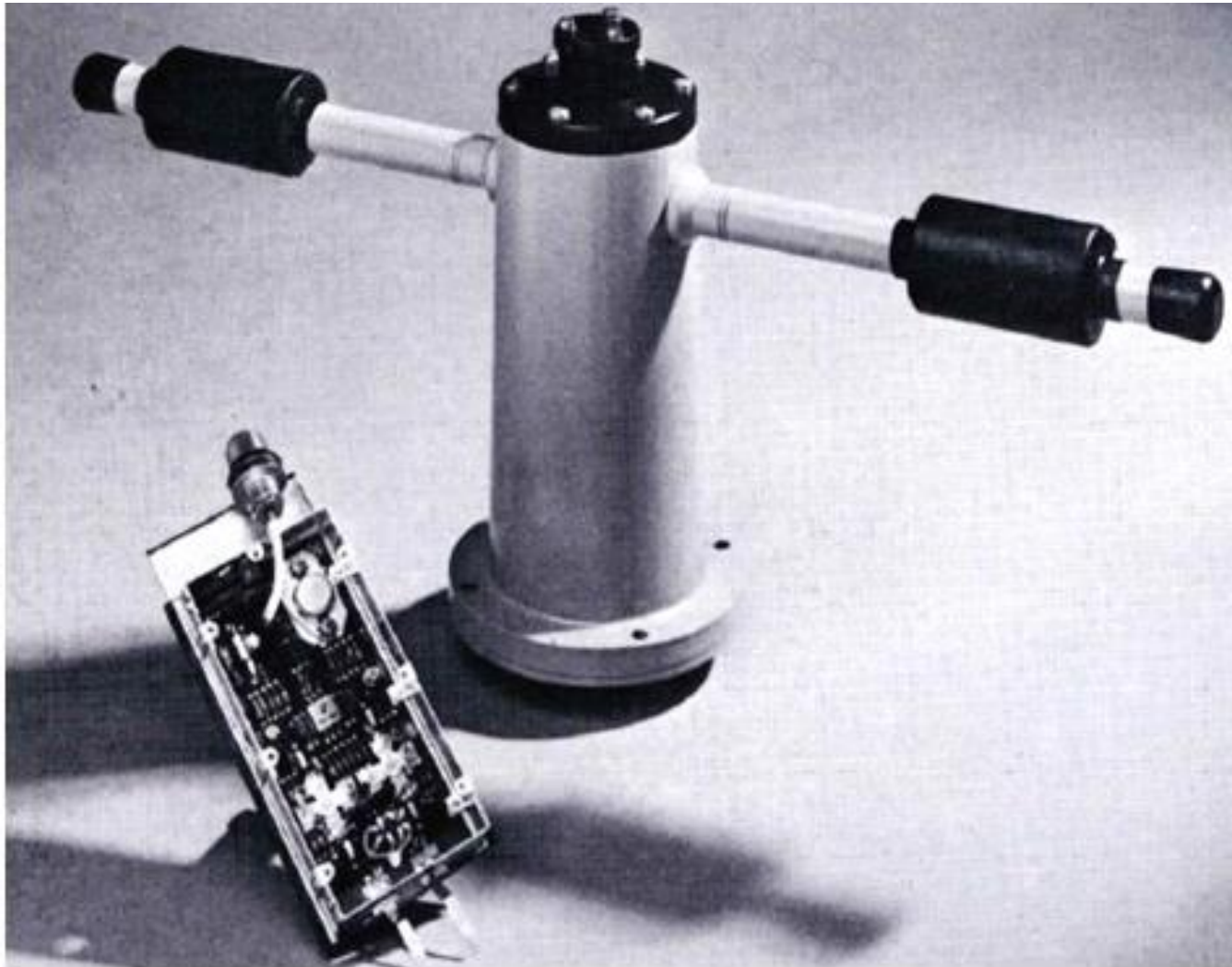

11 February 2016

ACTIVE VERTICAL DIPOLE ANTENNA HE309



LOW NOISE ACTIVE ANTENNA SYSTEM AM524

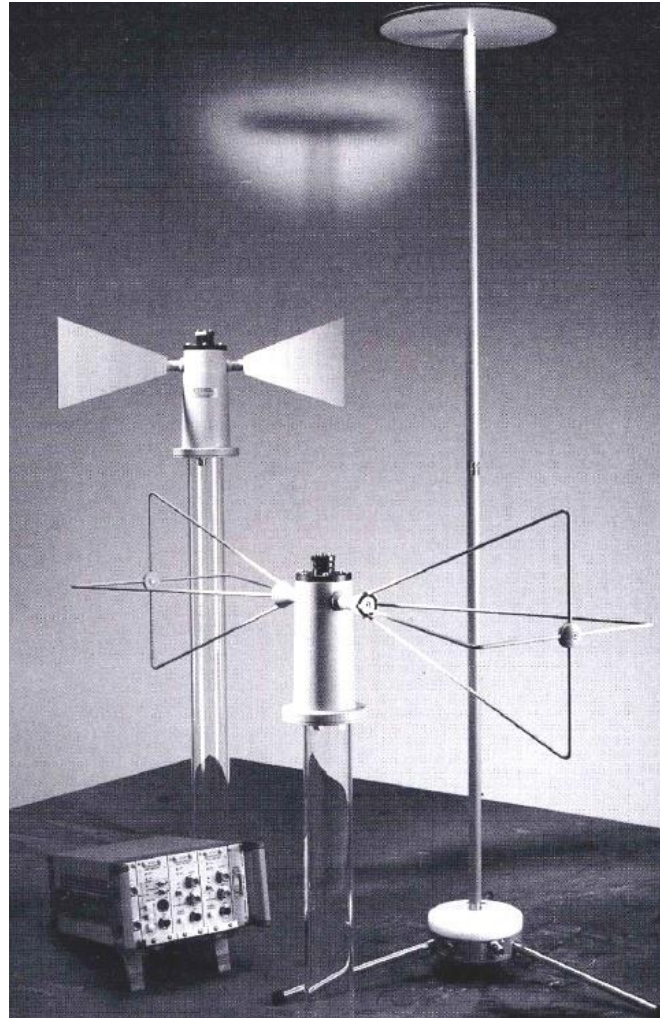

11 February 2016

TRANSMITTING- RECEIVING ANTENNA HX101 WITH BUILT-IN AUTOMATIC TUNER



The frequency range
is 30-80MHz

Military mobile
application

ACTIVE ANTENNA HE055

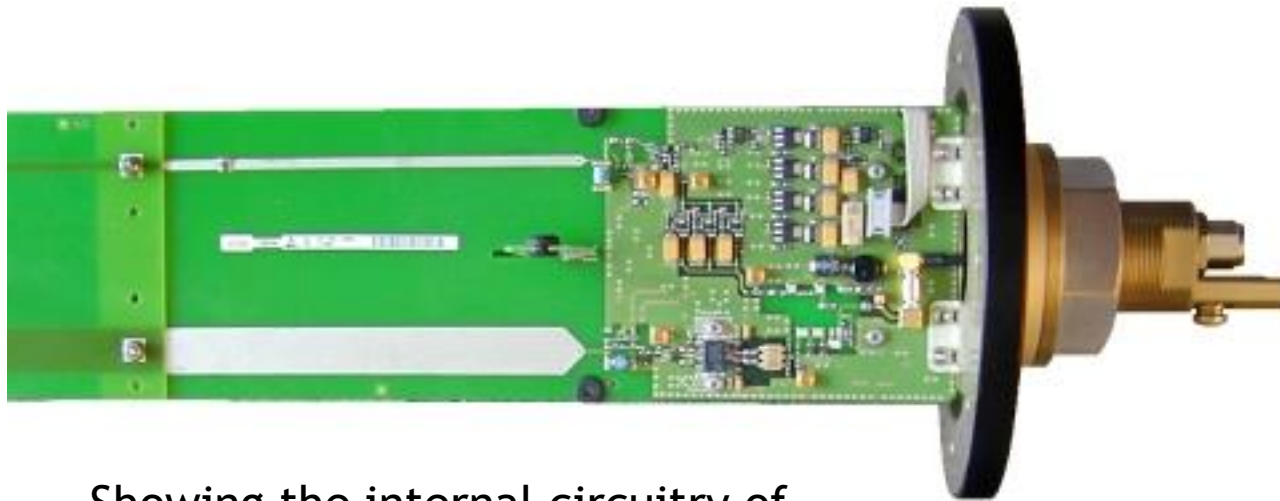

Showing the internal circuitry of the HE055 active antenna



FREQUENCY RESPONSE OF ANTENNA FACTOR OF AN ACTIVE ANTENNA

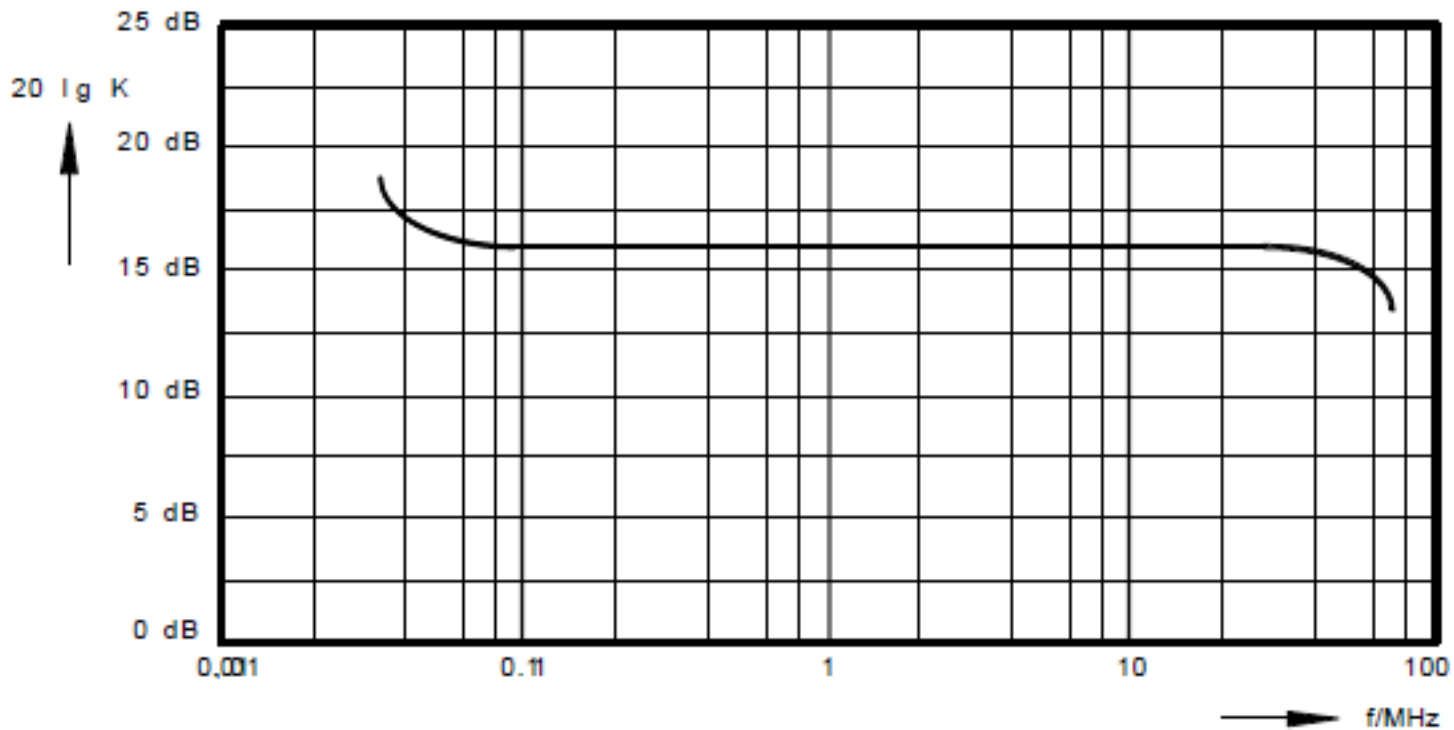

Frequency Response of Antenna Factor of an Active Antenna

ACTIVE ANTENNAS

- Active antennas are mainly but not exclusively used at low frequencies (down to approx. 200 MHz), at which the atmospheric noise is very high.
- Being extremely broadband, active antennas are increasingly used also at higher frequencies. In contrast to active antennas for the long-, medium and shortwave ranges, one cannot exclusively speak of electrically short radiators at higher frequencies.
- Electronic noise is no longer negligible at higher frequencies. This means that careful noise matching is required at the point where the source voltage is tapped at high impedance at the antenna terminals.

ACTIVE ANTENNAS CONT'D...

- ⦿ The small size of active antennas makes it possible to select the **direction of polarization** as required for the task on hand. For measurements, the direction of polarization is often defined in the test specifications.
- ⦿ It is of advantage that in many cases a single active dipole is sufficient for covering the entire frequency band in which measurements are performed and that due to the compact size of the antenna a change of polarization, if necessary, can be made in no time.

ACTIVE ANTENNAS CONT'D...

- Active antennas for radiomonitoring and radiodetection will be aligned in the direction of the incoming signal. This is very easy in the VHF-/UHF range, where signal polarization is mostly predictable. But with shortwaves for example, elliptical and thus non-predictable directions of polarization are obtained after a wave is reflected once by the ionosphere.
- It is quite common to make do with an active monopole, especially since for horizontally polarized dipoles the direction of incidence would have to be known.

ACTIVE ANTENNAS CONT'D...

- ◉ More complex, but also more effective is the use of two crossed, horizontally polarized active dipoles whose signals are added via a 90° coupler so that an omnidirectional radiation pattern of horizontal polarization is obtained (**turnstile antenna**).
- ◉ If, in addition, a monopole is stacked on the turnstile antenna and remote switching capability is added, any type of incoming wave can be handled.

ACTIVE MONOPOLE AND ACTIVE TURNSTILE ANTENNA WITH MONOPOLOLE STACKED ON TOP

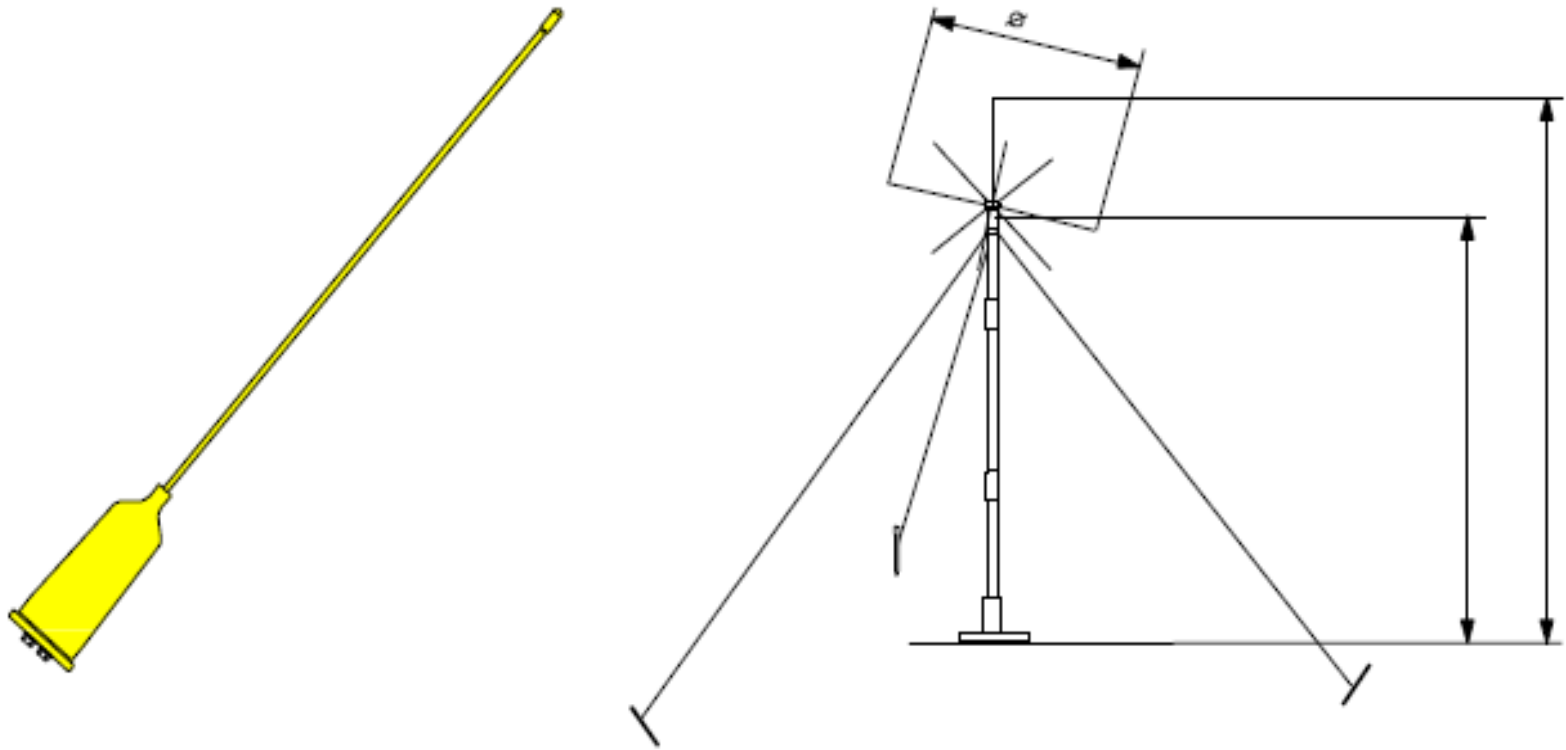

IMPORTANT POINTS FOR THE USE OF ACTIVE ANTENNAS

Active antennas...

- ⦿ ... are smaller than comparable passive antennas,
- ⦿ ... are more broadband than comparable passive antennas,
- ⦿ ... cannot be used for transmission,
- ⦿ ... are minimally coupled to their environment,
- ⦿ ... are more prone to failures if not properly mounted,
- ⦿ ... are very suitable as broadband test antennas,
- ⦿ ... have a frequency-independent radiation pattern,

IMPORTANT POINTS FOR THE USE OF ACTIVE ANTENNAS

Active antennas...

- ⦿ ... must have sufficient large-signal immunity,
- ⦿ ... must be balanced very carefully,
- ⦿ ... must not be located in electronic smog,
- ⦿ ... may be installed very close to each other,
- ⦿ ... are not as bad as one might think!

MOST IMPORTANT ANTENNA CHARACTERISTICS AT A GLANCE

Antenna type	Directivity factor	In dB	Effective length	Radiation resistance
Isotropic radiator	1	0	-	-
Electrically short antenna on conductive plane	3	4.7	$h/2$	$60 \left(\frac{\pi h}{\lambda} \right)^2 \Omega$
$\lambda/4$ antenna on conductive plane	3.3	5.1	0.16λ	36Ω
$5 \lambda/8$ antenna on conductive plane	6.6	8.2		
Electrically short dipole	1.5	1.8	$l/2$	$20 \left(\frac{\pi l}{\lambda} \right)^2 \Omega$
Half-wave dipole	1.64	2.1	$\lambda/\pi = 0.32 \lambda$	73Ω
Turnstile antenna	0.82	-0.86		
Full-wave dipole	2.4	3.8	$\gg \lambda$	200Ω
Small loop antenna with n loops	1.5	1.8	$n \cdot \frac{\pi^2 D^2}{2 \cdot \lambda}$	$20 \Omega \pi^6 n^2 (D/\lambda)^4$
Full-wave loop (ring, circumference = 1λ)	2.23	3.5		
Yagi-Uda antenna (6 elements)	typ. 10	typ. 10 dB		

ACTIVE ANTENNAS MATHEMATICS

- ◉ The electric field strength E generates a voltage (EMF) that can be determined from $V_a = E \cdot h_e$.
- ◉ The antenna has a capacitance C_A and for small electrical lengths, this is 25pF/meter, while the transistor has an input capacitance C_T . These two capacitances form a capacitive voltage divider.
- ◉ For electrically short antennas the voltage V_T is nearly independent of frequency
- ◉ The signal voltage that drives the transistor is then

$$V_T = \frac{E \cdot h_e}{1 + C_T / C_A}$$

ACTIVE ANTENNAS MATHEMATICS

- ⦿ The gain-bandwidth product of such a device can be computed from the performance of the field effect transistor. It will reproduce at the output the input voltage as long as its cut-off frequency is high enough.
- ⦿ Additional reactances (for frequency selectivity) may be added to intentionally limit the bandwidth of the active antenna.
- ⦿ Output power is not considered of primary importance since post amplifiers can always be added.
- ⦿ Therefore, only the signal-to-noise ratio is worth considering.

ACTIVE ANTENNAS CONT'D...

- ⦿ Assume that the active antenna has sufficient gain, the signal-to-noise ratio is determined by the active antenna and not by the receiver. The only internally generated noise is from the transistor since the passive antenna must be considered noise free.
- ⦿ In analyzing the output of the active antenna, there are three components to consider.
 - a) The signal voltage at the operating frequency,
 - b) The amplified noise generated by external sources (man-made or galactic), and
 - c) The transistor noise contribution.
- ⦿ As long as the noise voltage generated by the transistor at the amplifier output is less than the wideband noise picked up by the antenna, the system is capable of supplying the same signal-to-noise ratio as an optimized passive antenna for the same specific frequency

ACTIVE ANTENNAS - EXAMPLE

- Let us assume for a moment that we have an active antenna with a 1 meter long rod element. Its capacitance is 25pF. A typical value for the FET is 5pF or one fifth. Consequently 80 percent at the antenna output is applied to the FET input. If a passive full wavelength long dipole were used instead at, say, 10 MHz 30 meters long), the open-circuit voltage (EMF) would be 30 times higher than that generated by the 1 meter long rod. In addition, the atmospheric noise term would be greater.

ACTIVE ANTENNAS - EXAMPLE

- However, the 1 meter rod for all practical purposes generates the same, or practically the same, signal-to-noise ratio as a dipole with the difference that individual (signal and noise) levels are smaller.

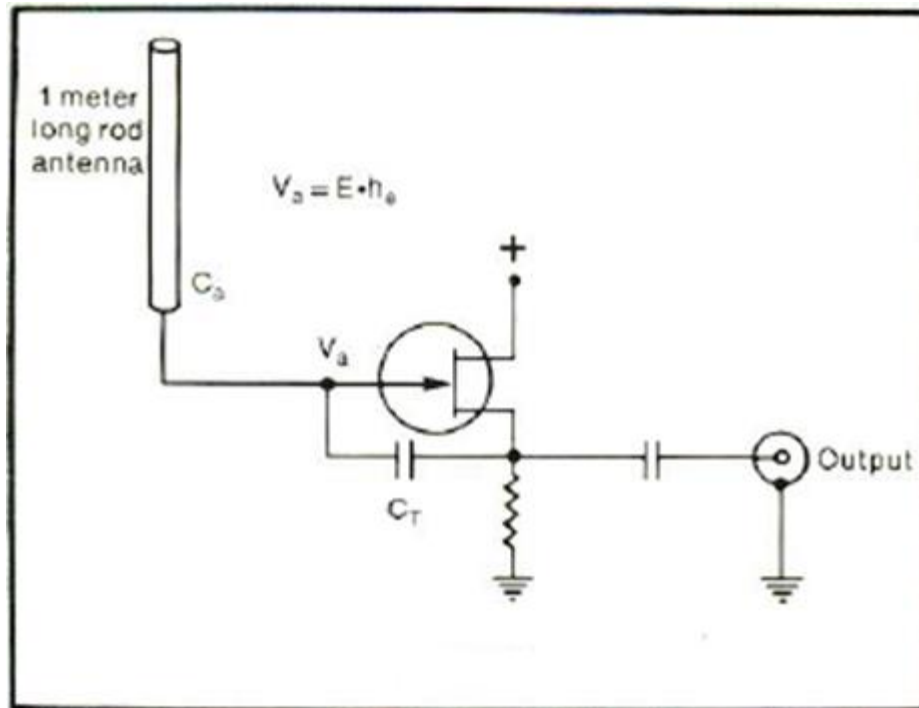

ATMOSPHERIC NOISE AS A FUNCTION OF FREQUENCY

- ⦿ The difference in amplitude can be compensated for by an amplifier under the restriction that atmospheric noise divided by the ratio at (full size antenna/1 meter) is equal to or better than the noise figure at the transistor amplifier.
- ⦿ The average noise power of the Ionosphere at these low frequencies is seen in figure next slide. These are the figures measured in typical rural areas.

ATMOSPHERIC NOISE AS A FUNCTION OF FREQUENCY

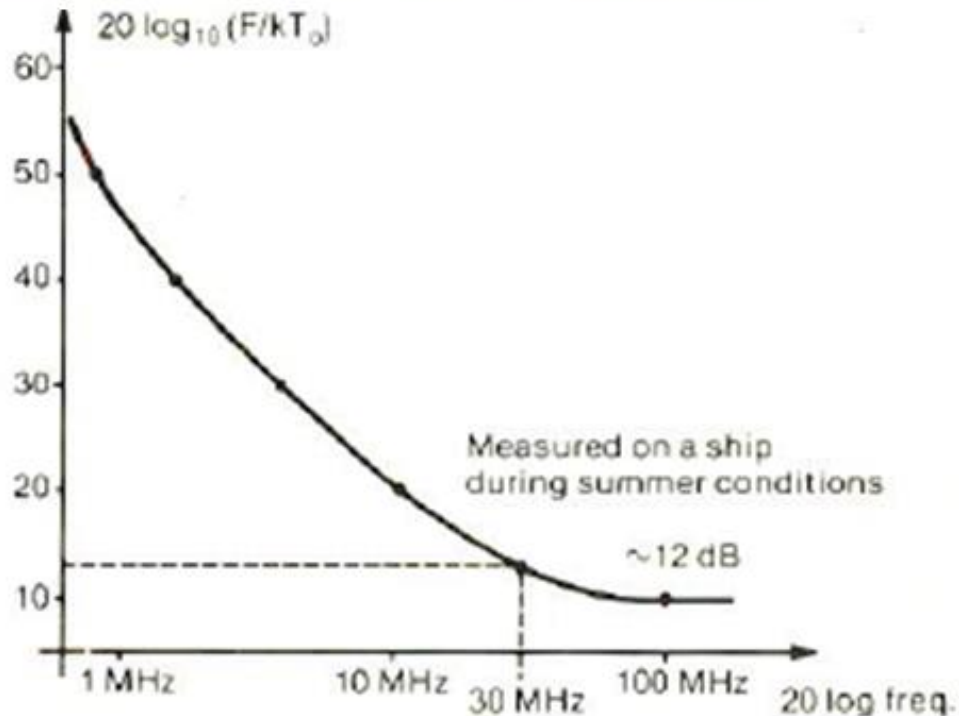

Atmospheric noise as a function of frequency.

- It becomes apparent that if these voltages are divided by 50, the noise floor approaches the noise floor of the best FETs, i.e. approximately 1 to 2dB.

INTERMODULATION DISTORTION

- ◉ Intermodulation distortion is another type of noise that is generated in the transistor or active device as a function of the input Signals.
- ◉ The active antenna, therefore, is best described by assigning to it a frequency range, a minimum sensitivity which is determined by the noise figure
- ◉ A dynamic range which is determined by the second, third, and higher-order intercept points, and Polarization (horizontal or vertical).

INTERMODULATION DISTORTION

- The simplest active antenna configuration using an FET is illustrated in the figure. This circuit exhibits high second order Inter-modulation distortion due to the antenna square-law characteristic.

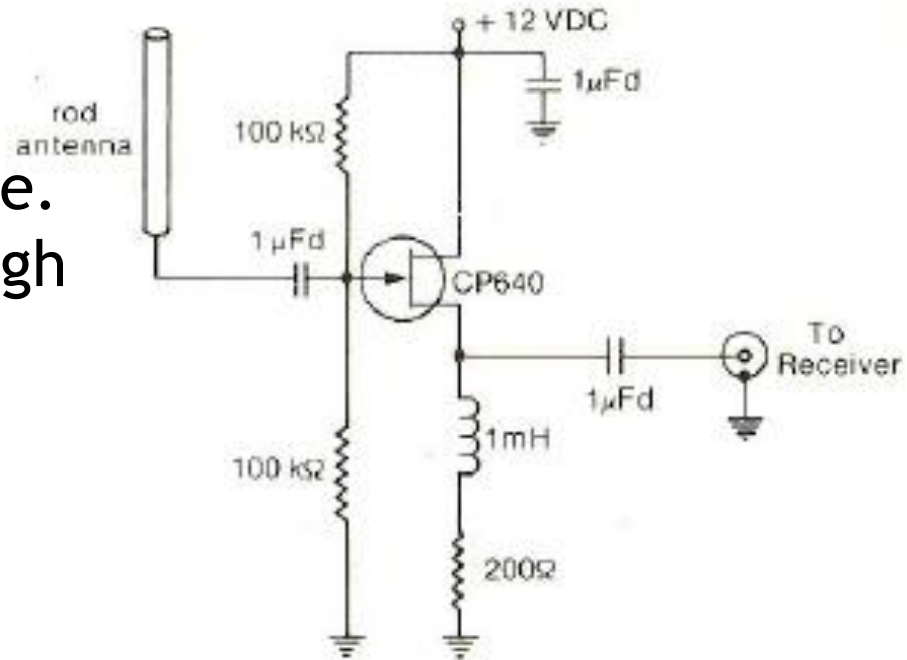

INTERMODULATION DISTORTION CONT'D...

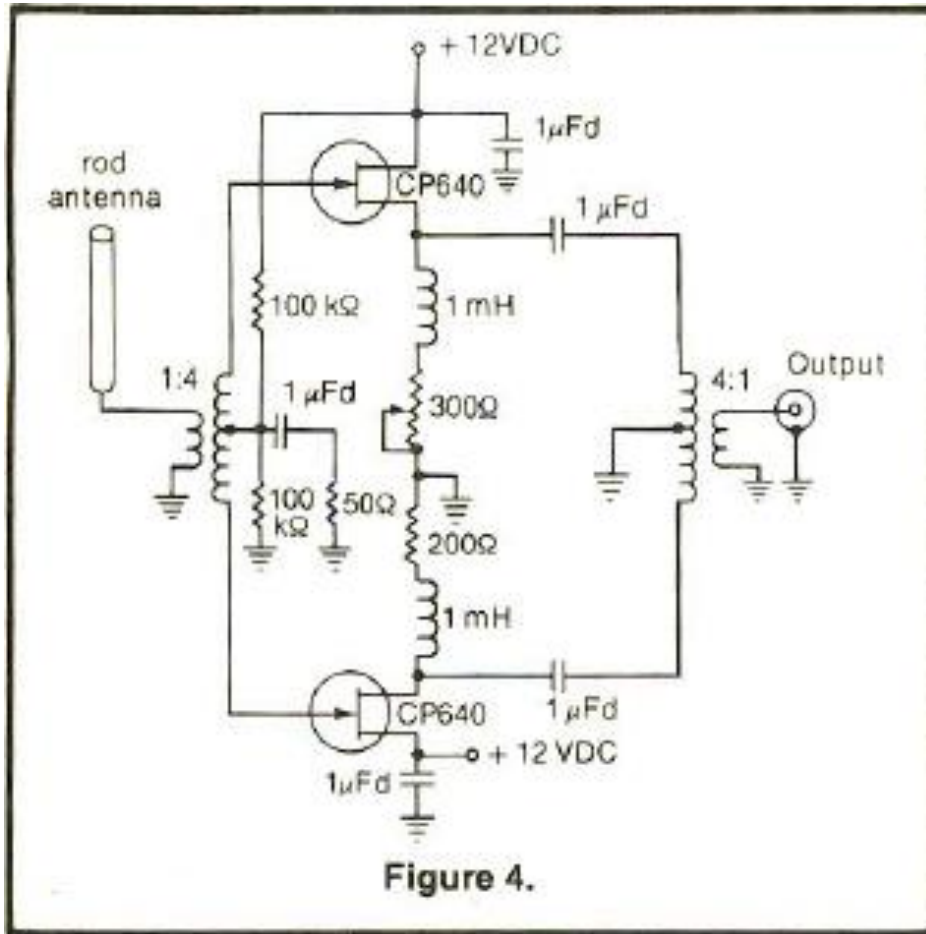

- A push-pull configuration that can be used for tests and evaluations of such a system is illustrated in the Figure.

ACTIVE ANTENNAS

- If the antenna is set for the greatest possible bandwidth, X_{OPT} becomes 0. This particular type of matching requires a high input impedance.
- The antenna noise figure then given by F_A is

$$F_A = C \left(\frac{R_A}{R_{OPT}} + \frac{R_{OPT}}{R_A} + \frac{X_A^2}{R_A R_{OPT}} - 2 \right)$$

$$\frac{R_A}{R_{OPT}} \ll \frac{R_{OPT}}{R_A}, \quad \frac{R_A}{R_{OPT}} + \frac{R_{OPT}}{R_A} + \frac{X_A^2}{R_A R_{OPT}} \gg 2$$

$$F_A = F_{\min} \left\{ 1 + \frac{C}{R_A} \left(R_{OPT} + \frac{X_A^2}{R_{OPT}} \right) \right\}$$

ACTIVE ANTENNAS CONT'D...

- System noise figure is defined by F_S and F_A is the antenna noise figure.
- The electrical gain of the antenna is defined by G_V
- For reasons of best dynamics, assume $V_a/V_0=0.5$
- With these assumptions in mind, the noise figure of the antenna now becomes $F_A = F_{\min} (1+A)$

$$F_S = F_A + \frac{(F_R - 1).a}{G_V}$$

$$G_V = 4 \left(\frac{V_a}{V_0} \right)^2 \cdot \frac{R_A}{Z_L} \quad F_A = F_{\min} \left\{ 1 + \frac{C}{R_A} \left(R_{OPT} + \frac{X_A^2}{R_{OPT}} \right) \right\} = F_{\min} (1 + A)$$

ACTIVE ANTENNAS CONT'D...

- Consequently, optimum matching resistance should be specified at the lowest operating frequency.
- Consider a 2-30 MHz active antenna. Its match resistance is 2466Ω (at 2 MHz). The antenna performance can now be determined if Z_A is known.
- The impedance diminishes much faster than the noise figure does (as a function of frequency).
- Using a rod antenna, its impedance is

$$Z_A \approx K_{R_1} \omega^2 + j \frac{k_{x_1}}{\omega}$$

LOSS AND NOISE FIGURE VERSUS FREQUENCY

- Table lists electronic losses and noise figure as a function of frequency. (This assumes that the noise figure of the active device is 2 dB).
- This data is also plotted in the next Figure. In this graph, the system's noise figure, the man-made noise, and some arbitrary noise specifications are plotted.

Table 2.

f (MHz)	G_V (dB)	$F_A \left(\frac{\text{dB}}{\text{kT}_0} \right) \approx F_S \left(\frac{\text{dB}}{\text{kT}_0} \right)$
2	-31	47.4
5	-21.7	35.2
10	-15.5	28.6
15	-12	24.9
20	-10.2	23.1
25	-7.3	20.2
30	-5.5	18.4

LOSS AND NOISE FIGURE VERSUS FREQUENCY

- Despite a loss of 30 dB {the active antenna relative to the power available at the antenna input} the signal-to-noise ratio up to 4 MHz can meet the specifications.
- Below 4 MHz, the specifications are equal to the man-made noise. Above 4 MHz the antenna's performance exceeds the specifications

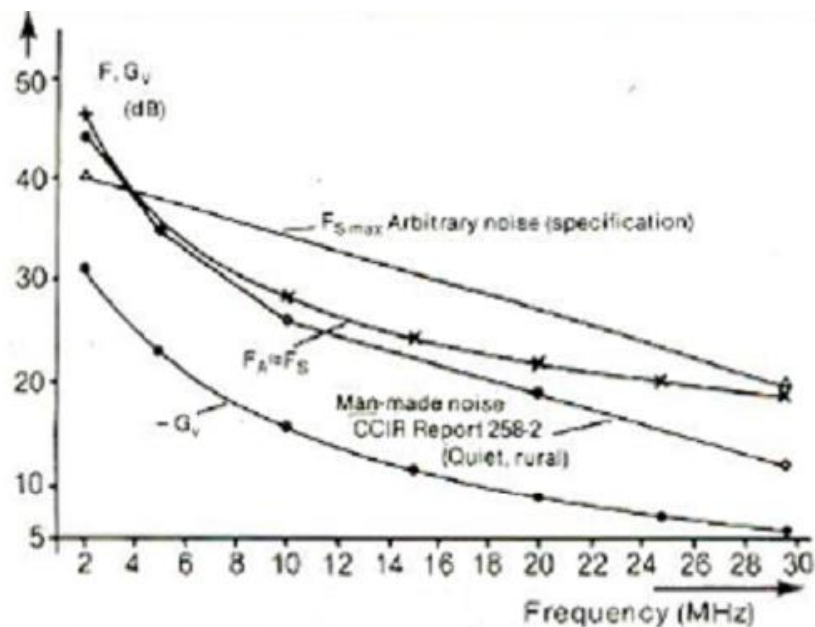

SHIPBOARD ENVIRONMENT SPECIFICATIONS

- The active antenna, per the specifications: sees two 10V EMF's. The intermodulation distortion products that are generated due to these two voltages are 40 dB above the specified maximum system's noise figure, as a worst case condition.
- At 2 MHz, F_s equals 40 dB and G_V equals - 31 dB.
- Therefore, $P_{am2,3} = -90\text{dBm}$. [ref. 11]

$$P_{an}(dBm) = F_s(dB) + G_V(dB) = 10 \cdot \log kT_0 B \cdot 10^3$$

$$P_{am}(dBm) = F_s(dB) = G_V(dB) - 139\text{dBm}$$

$$\begin{aligned} P_{am2,3\max}(dB) &= P_{an\min}(dBm) + 40\text{dB} \\ &= [F_s(dB) + G_V(dB)]_{\min} - 99\text{dBm} \end{aligned}$$

INTERCEPT POINT

CALCULATION

$$IP_2(dBm) = 2P_a(dBm) - P_{am2}(dBm)$$

$$P_a = \frac{V_a^2}{50\Omega}$$

- With $V_a/V_0=0.5$ and, $V_0=10V$, P_a is + 27 dBm, and, therefore, $IP_2 = 144$ dBm and $IP_3 = 85$ dBm. These are the two values that are required to generate an intermodulation distortion noise floor at the rated level.
- For practical considerations the 1 dB compression point should be 10 dB above the operating output level. Therefore, in this case, it should be + 37 dBm. This results in a voltage level of 44.3V at 0.9A in a 50 ohm system. The operating voltage of this amplifier should be set at 50V.
- If the input voltage ratio is changed and a higher than 0.5 voltage division ratio is utilized, then the second and third order Intercept points can be reduced.

INTERCEPT POINT CALCULATION

CONT'D...

- Let us assume that an intercept point of $IP_2 = 100$ dBm and IP_3 of 65 dBm can be reached. In a practical amplifier, the following results will then be obtained:
 - Second order intermodulation distortion products are going to be - 46 dBm and the useful dynamic range will be 84 dB.
 - Third order intermodulation products will be - 49 dBm and the useful dynamic range will be 81 dB.
- These calculations assume a noise figure of 40 dB at 2 MHz and two 10V random carriers generating the intermodulation distortion products as specified.

INTERCEPT POINT

- A number of tests in extremely hostile environments have already been performed with this active antenna. However, it is not yet in mass production and, therefore, not enough information about reproducibility is available. This will be the next step for evaluation.

Intercept point

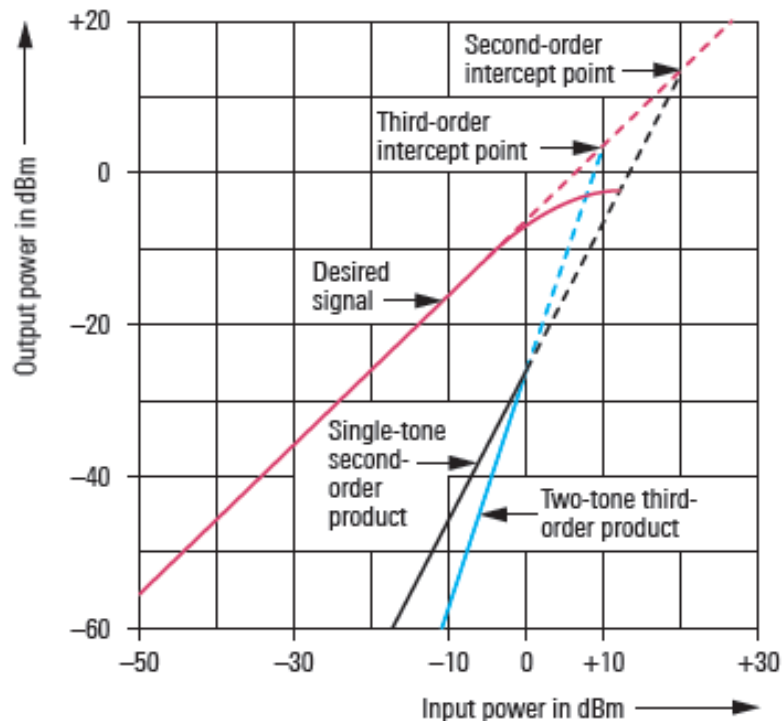

TWO-TONE INTERMODULATION

- For AM and CW/SSB Receivers, an important quantity is the two-tone dynamic range.
- While the dynamic range of a system is DR.
- This formula can be solved for the measurement of the intercept point.

$$DR = \frac{2[IP_3 - MDS]}{3}$$

$$IP_n = \frac{n.P_{ref} - P_{IMD}}{n-1} \Rightarrow IP_3 = \frac{3.P_{ref} - P_{IMD}}{2}$$

Example : When the Input = 2 × -10dBm, IMD product is -90dBm

$$IP_3 = \frac{3.(-10) - (-90)}{2} = \frac{-30 + 90}{2} = 30dBm$$

MEASURED TWO-TONE RESPONSE OF A DOUBLY BALANCED MIXER

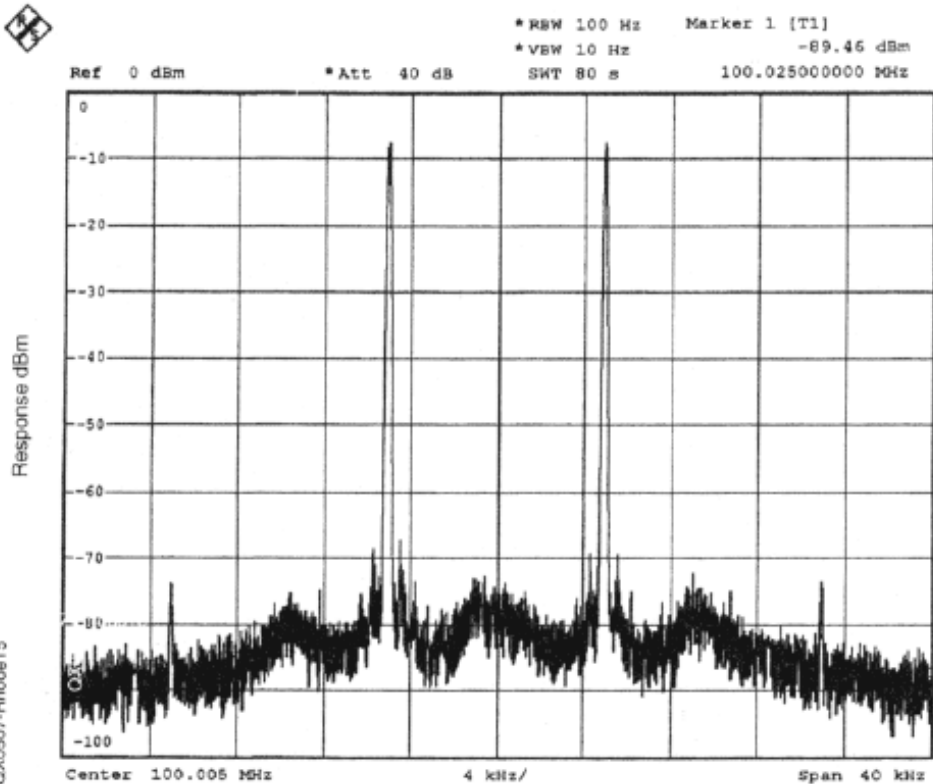

- The input signals are 0dBm, the insertion loss is 8dB and the IMD products are -74dBm
- The input intercept point (IP3 (IN)) can be calculated as follows:

Figure shows the measured two-tone response of a doubly balanced mixer.

$$IP_{3IN} = \frac{3 \cdot [(0) - (-74)]}{2} = 37 \text{ dBm}$$

IP3 DISTORTION PERFORMANCE

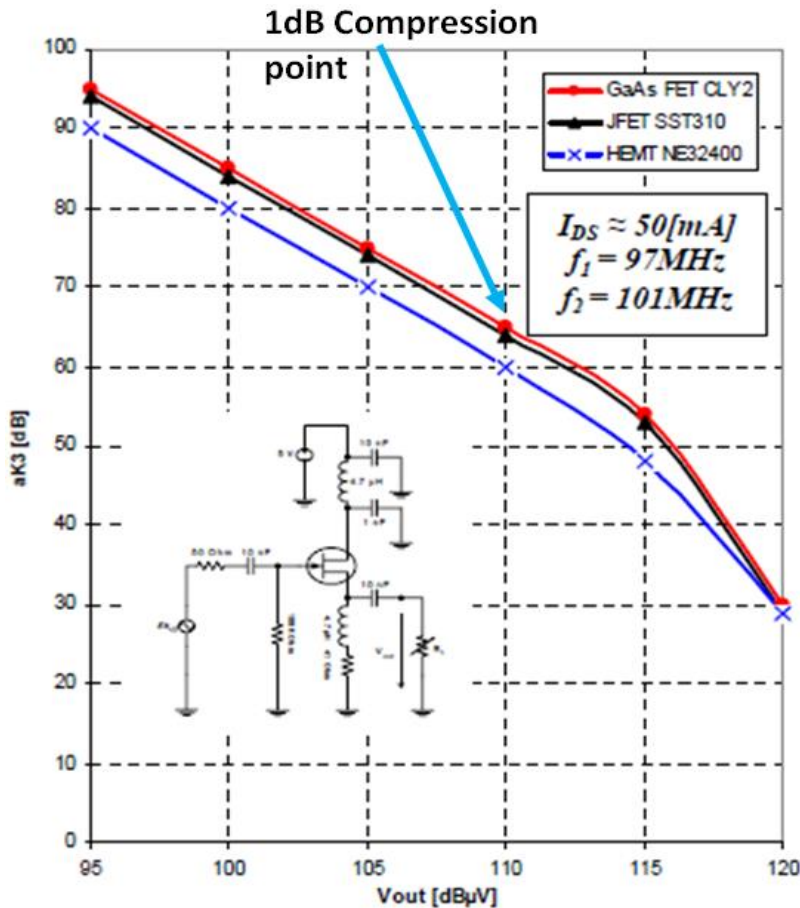

Simulated Third Order Inter-modulation Distortion Performance of the JFET, HEMT and GaAs FET Follower Cells in a 50 Ohm System

- Figure compares the simulation results of the inter-modulations distortion separation $aK3$ [dB] versus the circuit output voltage V_{out} [dB μ V] for the different selected transistors in a 50 Ohm system at the selected drain current of $I_{DS} \approx 50$ [mA].
- It is quite interesting to conclude that the JFET and GaAs FET share the same inter-modulation distortion behavior ($aK3$ [dB] @ $V_{out} = 100$ dB μ V ≈ 84.5 dB) and in addition better than the HEMT transistor ($aK3$ [dB] @ $V_{out} = 100$ dB μ V ≈ 80.2 dB).

DISTORTION PERFORMANCE FOR DIFFERENT R_S

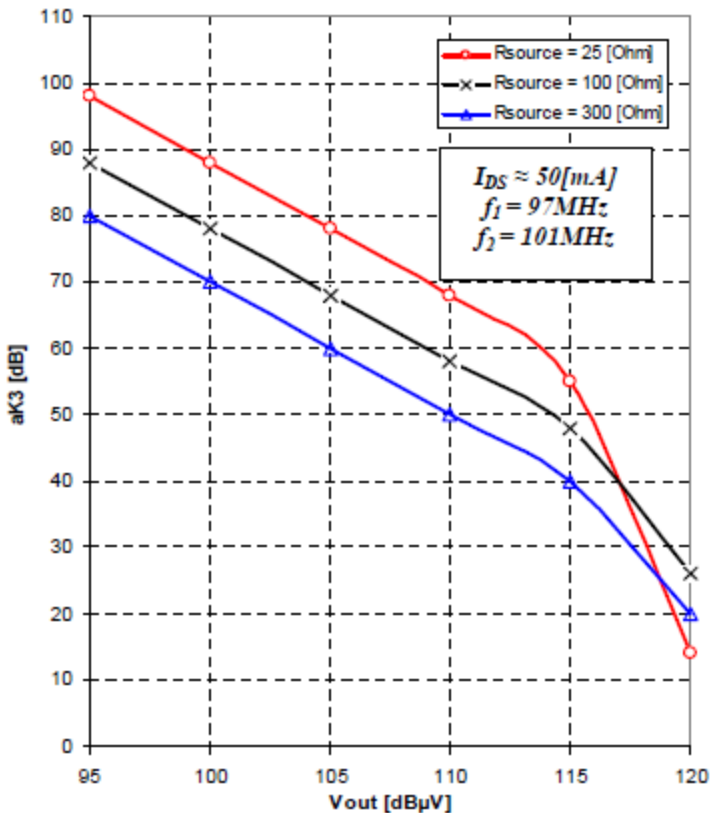
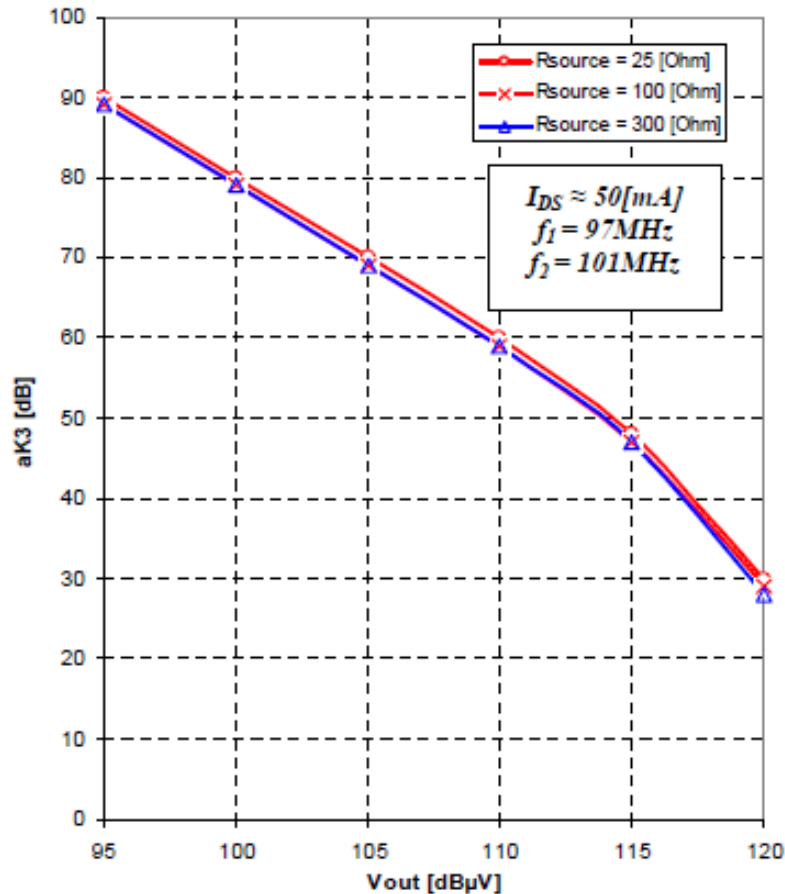

Figure shows, a JFET intermodulation distortion performance degradation is noticed as the source resistance varied

- For active antennas applications, the amplifier cell should have a constant third order inter-modulation distortion behavior independent on both source and load impedance possible variations (the variation is simply a representation of variable antenna impedance real part).
- Figure summarizes the simulation results done for the different selected
- transistors, which helps to select the optimum transistor for vehicles FM active antenna application.

CELL DISTORTION PERFORMANCE FOR R_S



HEMT Cell Simulated Distortion Performance at different variable source Resistance

- The HEMT and GaAs FET inter-modulation distortion is approximately constant and independent on the source impedance possible variations.
- Consequently, the HEMT and GaAs FET can be used for FM active antennas applications, however since the GaAs FET has a better inter-modulation distortion behavior, one can conclude that the GaAs FET is the optimum transistor for FM active antennas applications.

EFFECT OF LOAD RESISTANCE VARIATION IP3

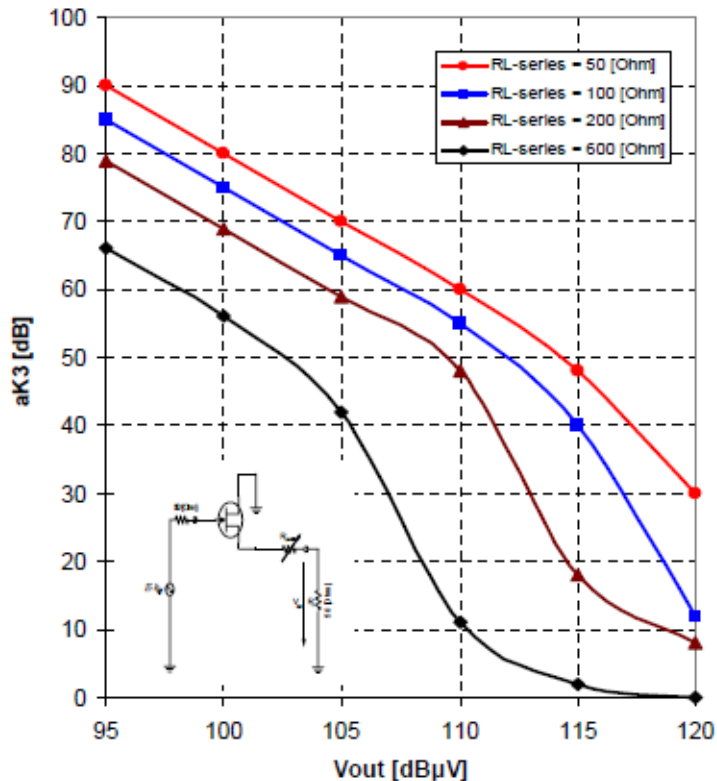

Effect of Load Resistance variation on the GaAs FET Follower Cell Third Order Intermodulation Distortion Performance

- The increase of RL-series far away from the optimum value (500hm) results in the circuit power gain reduction, which in turn reduces the total circuit intermodulation separation aK3.

CELL DISTORTION PERFORMANCE FOR LOAD RESISTANCE

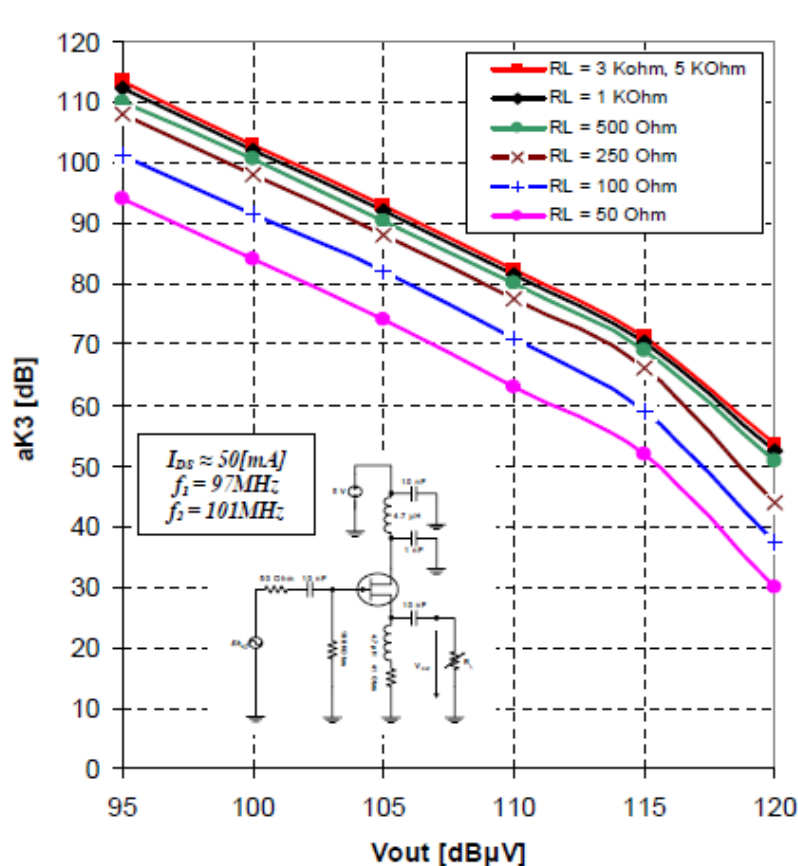

Simulation of GaAs FET Follower Cell Distortion Performance for Variable Load Resistance RL

- For a source resistance of $R_S = 50 \text{ Ohm}$ and R_L -series = Zero
- Ohm, the value of R_L is varied from 50Ω - $5K\Omega$, and then the third order inter-modulation separation $aK3$ is evaluated via simulations as shown in figure and shows that the inter-modulation distortion separation reached a maximum value of $103dB$ for an output voltage of $100dB\mu V$ at $R_L = 5K\Omega$.
- It should be noted that load resistance R_L in principle functions as a feedback for the source follower

EFFECT OF DRAIN CURRENT ON IP3

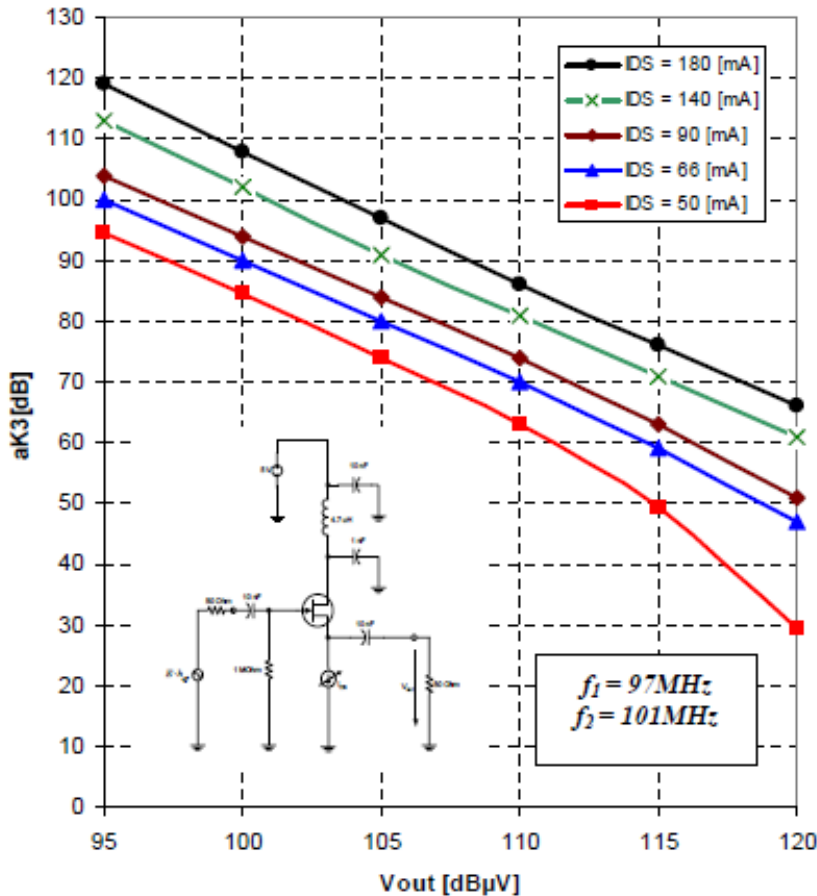

Effect of Drain Current Bias on the Follower Cell Third Order Inter-modulation Distortion Performance

- GaAs FET Follower Cell Simulated Distortion Performance at different Bias Current
- The follower cell introduces a considerable enhancement of the inter-modulation distortion separation for higher currents, whereas a variable current source value is varied for the necessary simulation requirement ; however, the transistor limits the follower circuit performance power consumption

CELL DISTORTION PERFORMANCE

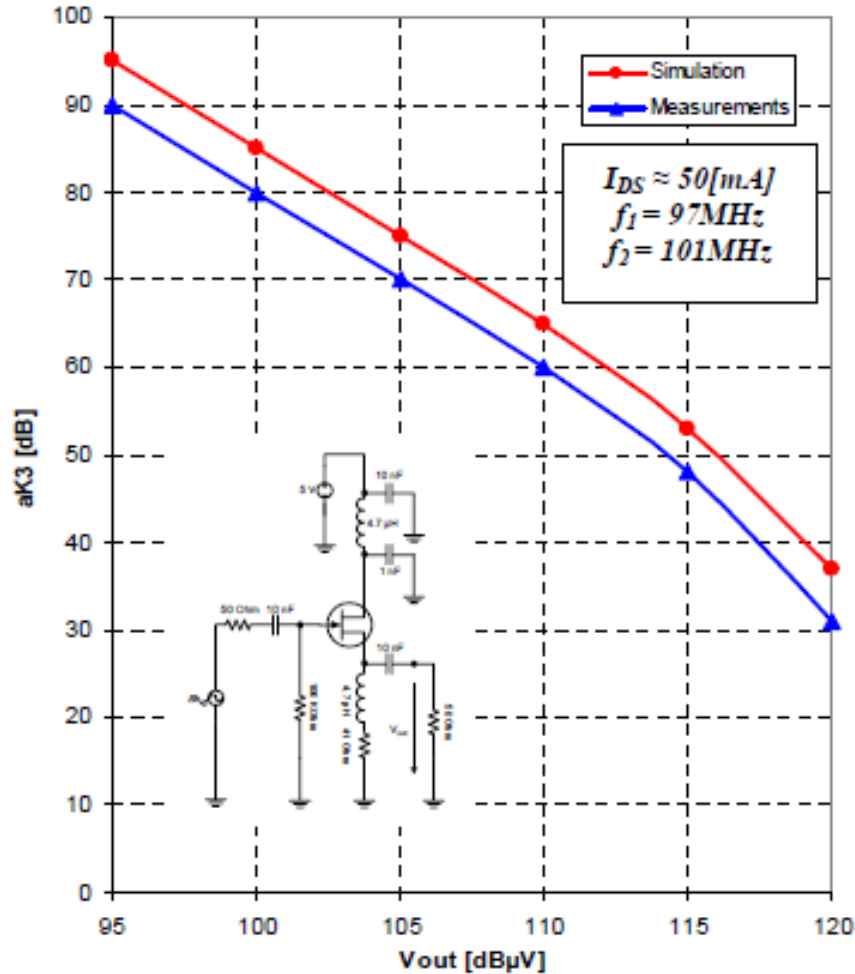

Simulation and Measurements of GaAs FET Follower Cell Distortion Performance

USE A POWER TRANSISTOR - 7GHz DEVICE, SINGLE CELL

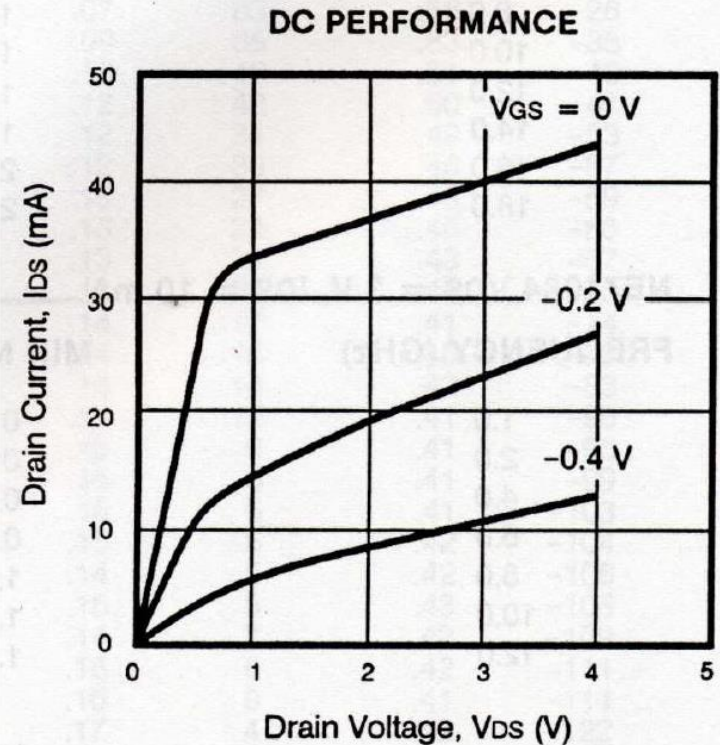
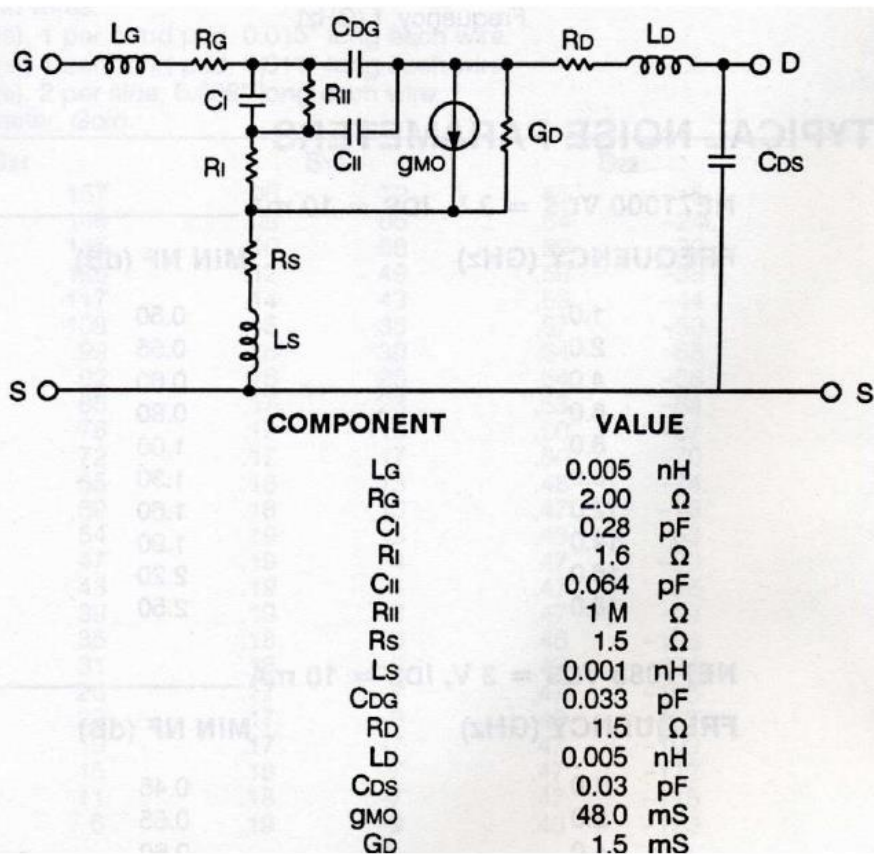
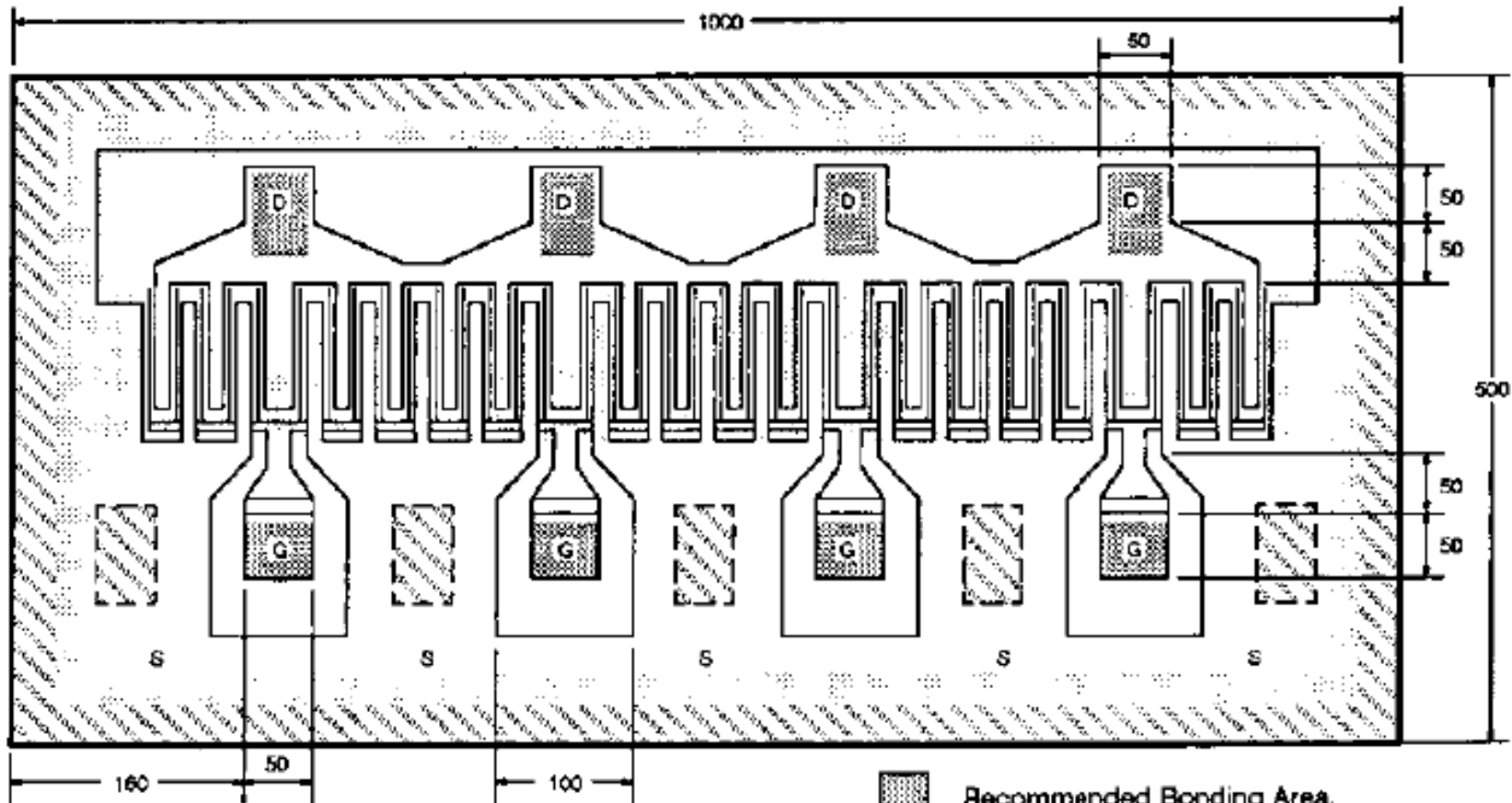





Figure shows small signal equivalent circuit

FULL DEVICE

NE900400G (CHIP)
(Units in μm)



Die Thickness: 40 to 80 μm

-  Recommended Bonding Area.
-  Glassivated Area
-  Plated Wraparound Area and Via Hole detail.

LINEARITY MEASUREMENTS

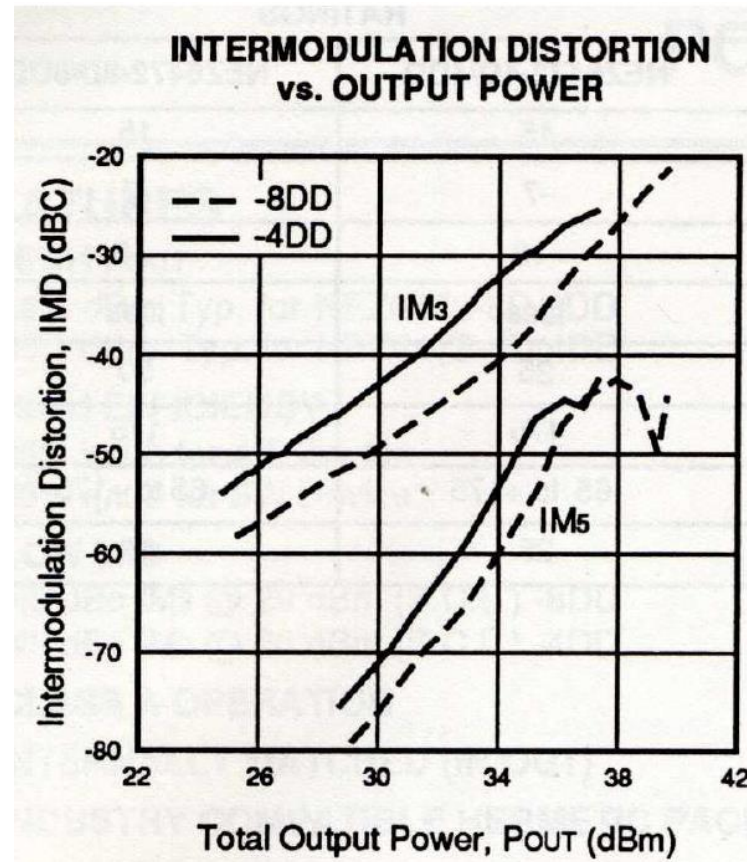
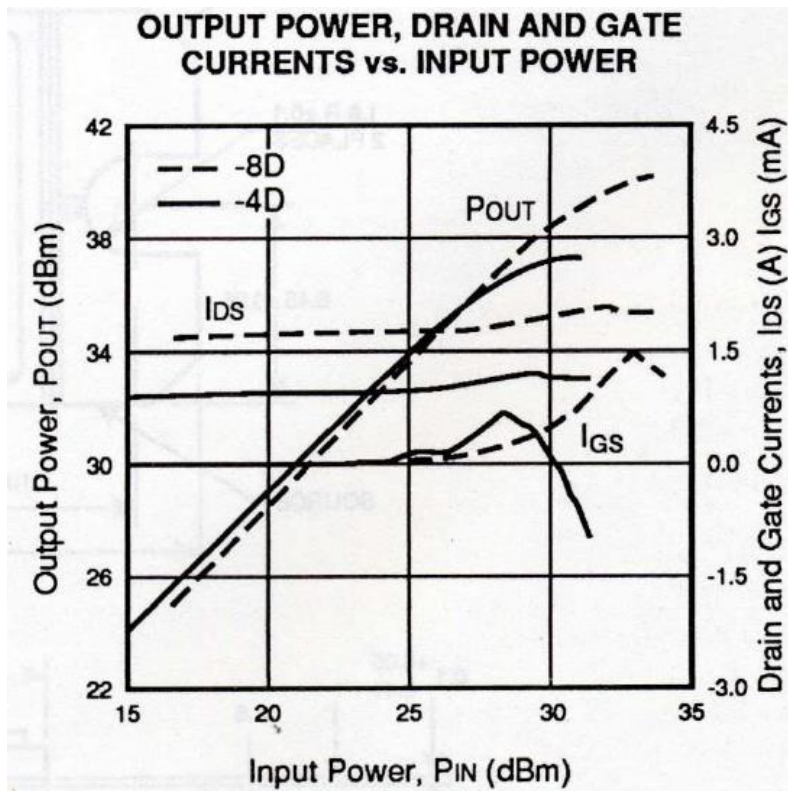

REFERENCES

1. U.L.Rohde, 'Die Anpassung von kurzen Stabantennen für KW-Sender', Funkschau 1974, heft 7.
2. Match antenna over 1.5to 30MHz range with only two adjustable elements, electronic design 19, Sept 13 1975
3. William E Sabin and Edgar O. Schoenike, 'Single sideband systems and circuits', McGraw hill second edition page 582-605.
4. RCA, RF power transistor manual, chapter Design techniques for RF power amplifiers, page 49-63.
5. The ARRL handbook for radio communications 2013 chapter 22 Antennas and chapter 18 page 18.6
6. <http://en.wikipedia.org/wiki/Antenna>
7. http://en.wikipedia.org/wiki/Antenna_tuner
8. http://en.wikipedia.org/wiki/Active_antenna
9. http://en.wikipedia.org/wiki/File:Spark_gap_transmitter_diagram.png.
10. Christof Rohner, Rohde & Schwarz - Antenna Basics
11. Ulrich. L. Rohde, "Active Antennas", RF Design, May/June 1981
12. "Active Receiving Antennas", www.electronics-tutorials.com
13. Ulrich. L. Rohde, "Receiver Measurements, How to evaluate Receivers", QEX, July/Aug 2005
14. R. A. Sainati, D. E. Fessenden, "Performance of an Electrically Small Antenna Amplifier Circuit
15. William E. Sabin, Edgar O. Schoenike, "Single sideband systems and Circuits", Ch-15, McGraw Hill Inc.
16. Ashraf Ramadan, "Active Antennas with High Input Impedance Low Noise and Highly Linear Amplifiers", Ph.D Dissertation, July 2005
17. Ulrich. L. Rohde, "Theory of Intermodulation and Reciprocal Mixing: Practice, Definitions and Measurements in Devices and Systems, Part 1, QEX, Nov/Dec 2002
18. Ulrich. L. Rohde, "Theory of Intermodulation and Reciprocal Mixing: Practice, Definitions and Measurements in Devices and Systems, Part 2, QEX, Jan/Feb 2003
19. Ulrich. L. Rohde, "From Spark Generators to Modern VHF/UHF/SHF Voltage Controlled Oscillators", QEX, July/Aug 2008

ACKNOWLEDGEMENT



**Rucha Lakhe -
Passive antennas**



**Anisha Apte -
Active antennas**

QUESTIONS

????

So Any ?